

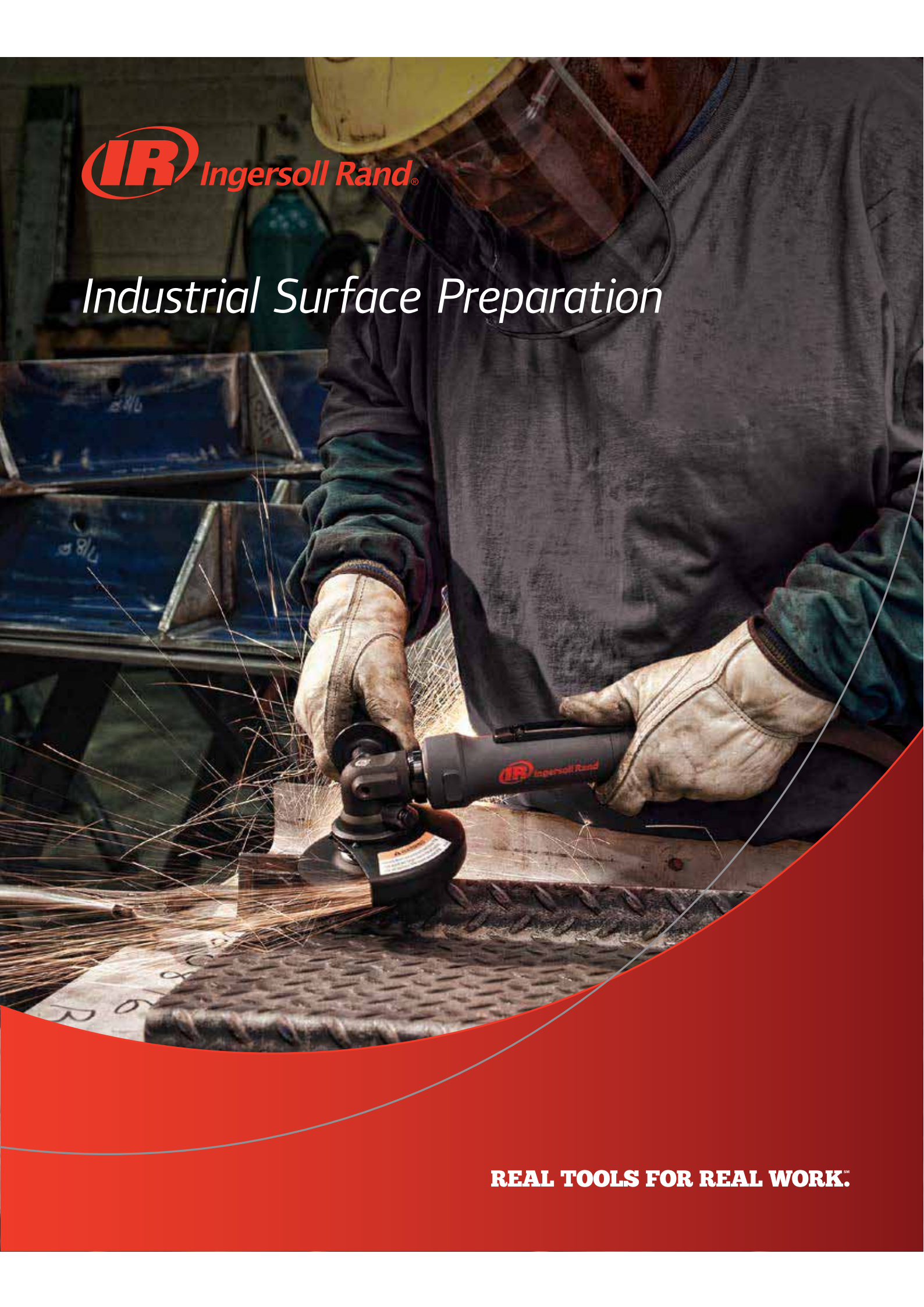

Industrial Surface Preparation



REAL TOOLS FOR REAL WORK.™

Contents

Industrial Grinders.....4



Created for non-production industrial applications, the Revolution Series delivers high performance at an affordable price. They're available in straight, extended, or 90-degree angle head configurations, multiple speed capacities, and offer various attachments.

Finishing Tools.....33



Ingersoll Rand offers a host of finishing tools to accomplish a variety of surface preparation tasks, whether heavy-duty or intricate in nature.

Pro-Series™ Grinders.....21



Pro-Series grinders are designed for heavy material removal. They feature best-in-class vibration dampening technologies, patented integral guards, and self-locking, spring-loaded throttle levers that prevent accidental operation.

Random Orbital Sanders.....38



Lightweight sanders offer unsurpassed reliability for the finest in swirl-free finishes. They are available in non-vacuum, vacuum-ready, and venturi-vacuum models.

Pro-Series™ Finishing Tools.....29



Ingersoll Rand industrial sanders, polishers, and buffers have been developed for specific use in surface preparation and final finishing applications. They're the perfect multipurpose accessory tools for a variety of applications.





















Accessories.....43



ARO offers an extensive line of air line filters, regulators and lubricators, including individual units, piggybacks and combos, to meet your exact air preparation requirements.

Symbols

For ease of use, specification tables frequently use symbols in column headings. Please reference the chart below for exact descriptions.

 Rated power	 Sound level	 Angle head height
 Max. free speed	 Tool weight	 Collet capacity
 Vibration level	 Tool air inlet connection	 Side-to-center distance
 Tool length	 Backing pad thread size	 Bore
 Max. air consumption	 Wheel diameter	 Piston stroke
 Height above spindle	 Wheel type	 Blows per minute
 Spindle thread size	 Voltage	

Industrial Grinders



Advancements in manufacturing and production continue to transform the nature of industrial finishing. While traditional, heavy-duty material removal continues in many segments, increases in precision and reductions in waste are changing overall demands. New materials require different tool speeds and attachments; parts and components must match surrounding surfaces with greater accuracy.

For more than 100 years, Ingersoll Rand has helped transform the way the industry works. We've combined the best engineering talent, top-quality materials, and superior customer service in delivering tools with unmatched power and durability. Our designs reflect emerging trends in finishing tool use, changing technology, and new materials.

Whatever the application, Ingersoll Rand finishing tools bring out the best in your operators' skills, and contribute to the ultimate quality of your products and processes.

Wheel Types and Collets

STRAIGHT GRINDERS



Type 1 Wheels

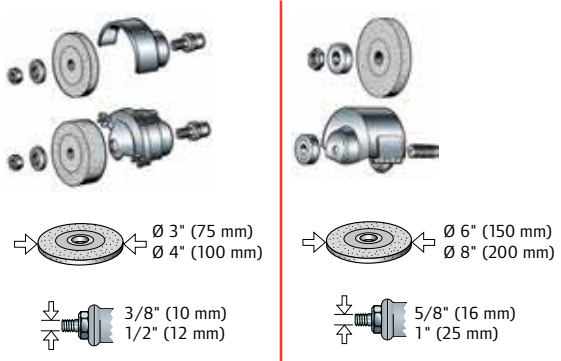

VERTICAL AND ANGLE GRINDERS



Type 27 Depressed Center Flat Wheels

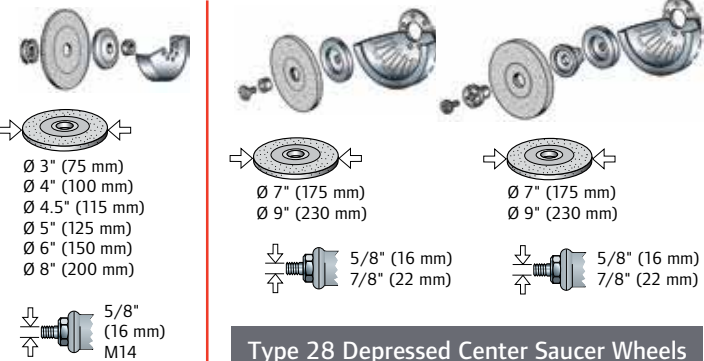

CONE AND PLUG WHEEL GRINDERS



Type 16, 17, 18, 18R, and 19 Cone and Plug Wheels

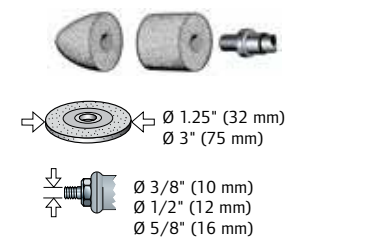

COLLET TYPE GRINDERS



Mounted Wheels and High Speed Steel or Carbide Burs

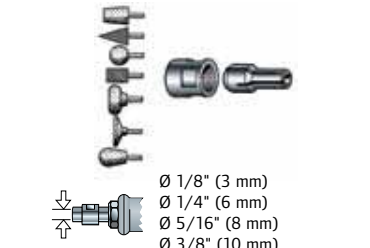

Type 28 Depressed Center Saucer Wheels

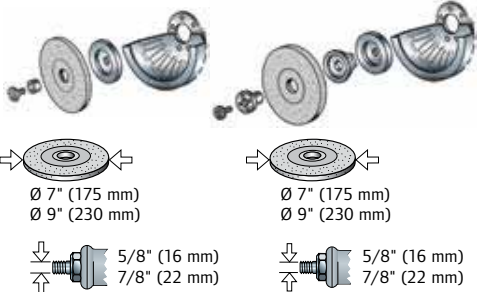

Type 6 and 11 Cup Wheels

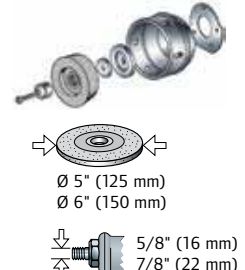

Type 13 1" Saucer Wheels

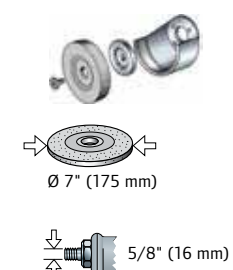

G and M Series Grinders

G1 SERIES



- At 0.4 hp, the G1 Series packs a lot of power in a small package.
- Ideal for light material removal, cleaning rough castings, deburring parts, cleaning up welds, and other finishing tasks.
- Ergonomic D-shaped handle fits better in your hand.
- Low noise and vibration.
- One-nut access for all motor servicing.
- Available in angle, horizontal, and extended horizontal configurations.

M2 SERIES



- Lube-free, 0.75 kW (1 hp) motors run cooler and longer for less maintenance.
- Speed-governed motors help maximize the life of abrasives, increasing grinder efficiency and improving productivity.
- Spindle locks make changing accessories faster and easier.
- Suited for heavier-duty grinding, cutting, cleaning, and polishing applications.
- Different speed ratings across the full range of M2 Series tools ensure there's a grinder or sander for virtually any job.

G3 SERIES



- Superior power-to-weight ratio — the G3 Series delivers a mighty 1.35 hp.
- The biggest jobs demand the most power.
- Internal contamination-free air controller helps maintain tool speed to maximize material removal rate.
- Ideal for industrial-duty material removal with burrs, grinding wheels, and coated abrasives.
- Available in angle, horizontal, extended horizontal, and extended angle configurations.
- Vibration-reducing handle, allowing end user extended operation.

Our G1, M2, and G3 Series grinders easily withstand the rigors of today's most demanding industrial environments and conditions, delivering power and precision for enhanced performance. With a G-Series grinder, you'll get the job done faster and more reliably. You'll have shorter downtimes and need fewer parts in inventory, thanks to their easy serviceability.

G-Series grinders are ergonomically designed, which makes them easier and more comfortable to use. Plus, Ingersoll Rand backs them with a two-year extended warranty option — the best in the industry!

M2 Series Grinders— Welcome To The Family.

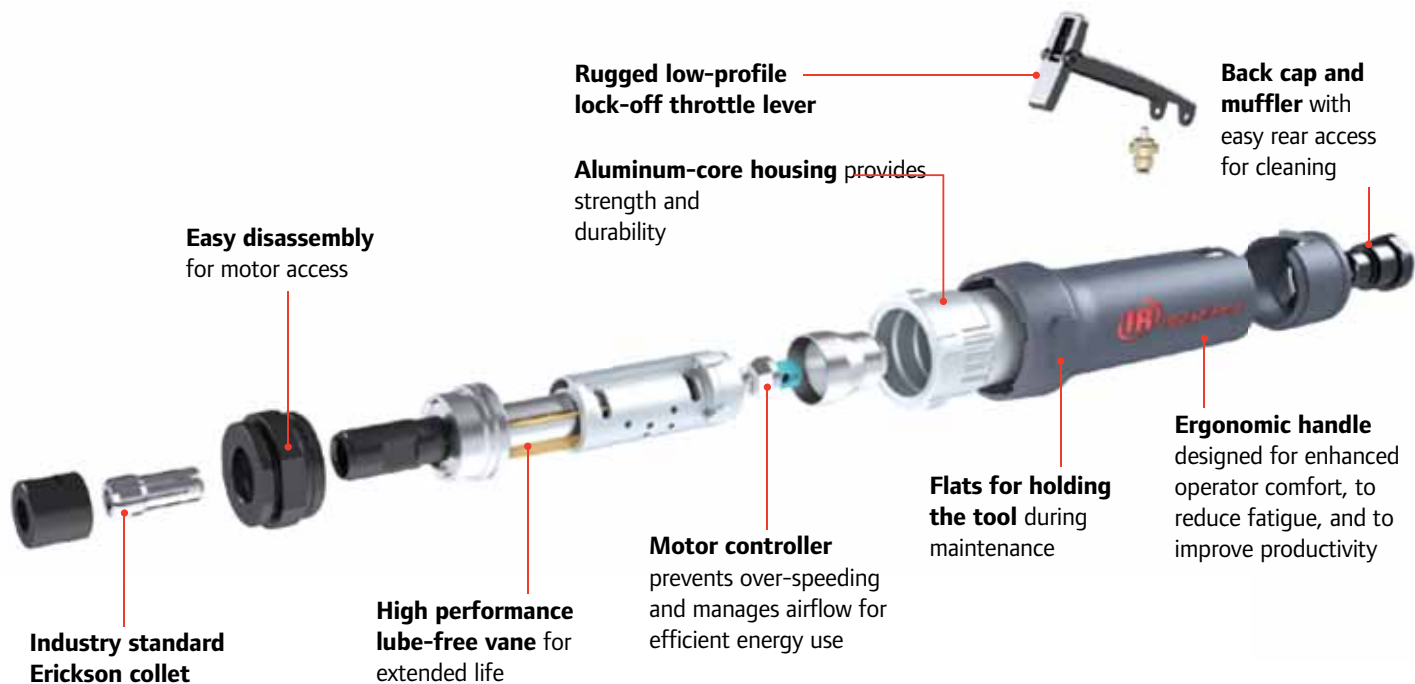

G1 Series



G1A200RG4



G1A200RH63



G1A200RS812



G1H200FG4



G1H200RH63



G1X350RG4

Model	hp	rpm	Exhaust	Output	Type	lb (kg)	(mm) in	in (mm)	cfm
G-SERIES ANGLE GRINDERS									
G1A120FG4	0.4	12,000	Front	1/4" collet	N/A	1.1 (0.5)	152 (6.0)	3.0" (76)	19
G1A120RG4	0.4	12,000	Rear	1/4" collet	N/A	1.1 (0.5)	152 (6.0)	3.0" (76)	19
G1A200FG4	0.4	20,000	Front	1/4" collet	N/A	1.1 (0.5)	152 (6.0)	3.0" (76)	25
G1A200RG4	0.4	20,000	Rear	1/4" collet	N/A	1.1 (0.5)	152 (6.0)	3.0" (76)	25
G1A200RH63	0.4	20,000	Rear	3/8" – 24 thread, 3" guard	1	1.3 (0.6)	152 (6.0)	1.9" (48)	25
G1A200RP63	0.4	20,000	Rear	3/8" – 24 thread, 3" guard	27, 28	1.3 (0.6)	152 (6.0)	1.9" (48)	25
G-SERIES ANGLE SANDERS									
G1A120RS418	0.4	12,000	Rear	1/4" x 18" belt	N/A	1.2 (0.5)	355 (14.0)	N/A	19
G1A120RS4	0.4	12,000	Rear	1/4" – 20 thread	N/A	1.1 (0.5)	152 (6.0)	3.0" (76)	19
G1A120RS812	0.4	12,000	Rear	1/2" x 12" belt	N/A	1.2 (0.5)	274 (10.8)	N/A	19
G1A120RS818	0.4	12,000	Rear	1/2" x 18" belt	N/A	1.5 (0.7)	355 (14.0)	N/A	19
G1A200RS4	0.4	20,000	Rear	1/4" – 20 thread	N/A	1.1 (0.5)	152 (6.0)	3.0" (76)	25
G1A200RS812	0.4	20,000	Rear	1/2" x 12" belt	N/A	1.2 (0.5)	274 (10.8)	N/A	25
G1A200RS818	0.4	20,000	Rear	1/2" x 18" belt	N/A	1.5 (0.7)	355 (14.0)	N/A	25
G-SERIES HORIZONTAL GRINDERS									
G1H200FG4	0.4	20,000	Front	1/4" collet	N/A	0.9 (0.4)	155 (6.1)	N/A	19
G1H200RG4	0.4	20,000	Rear	1/4" collet	N/A	0.9 (0.4)	155 (6.1)	N/A	19
G1H200RH63	0.4	20,000	Rear	3/8" – 24 thread, 3" guard	1	1.2 (0.5)	155 (6.1)	N/A	19
G1H250RH63	0.4	25,000	Rear	3/8" – 24 thread, 3" guard	1	1.2 (0.5)	155 (6.1)	N/A	20
G1H250FG4	0.4	25,000	Front	1/4" collet	N/A	0.9 (0.4)	155 (6.1)	N/A	20
G1H250RG4	0.4	25,000	Rear	1/4" collet	N/A	0.9 (0.4)	155 (6.1)	N/A	20
G1H350FG4	0.4	35,000	Front	1/4" collet	N/A	0.9 (0.4)	155 (6.1)	N/A	25
G1H350RG4	0.4	35,000	Rear	1/4" collet	N/A	0.9 (0.4)	155 (6.1)	N/A	25
G-SERIES EXTENDED HORIZONTAL GRINDERS									
G1X200RG4	0.4	20,000	Rear	1/4" collet	N/A	1.3 (0.6)	231 (9.1)	N/A	25
G1X250RG4	0.4	25,000	Rear	1/4" collet	N/A	1.3 (0.6)	231 (9.1)	N/A	25
G1X350RG4	0.4	35,000	Rear	1/4" collet	N/A	1.3 (0.6)	231 (9.1)	N/A	25

M2 Series





M2A120RP945



M2A180RG4



M2H200RG4

Model							Height over spindle end	Air flow on load/no load	Vibration/K*
	(rpm)	Output	Type	kg (lbs.)	mm (in)		mm (in)	(L/s)	(m/s ²)
M2 SERIES ANGLE GRINDERS									
M2A090RP95	9,000	M14 THD	Wire Brush – 5" max	1.62 (3.56)	236 (9.29)		86 (3.39)	19.8 / 10.4	4.6 / 1.6
M2A120RG4	12,000	Collet (6 mm & 1/4")	Burr	1.62 (3.56)	227 (8.94)		83 (3.28)	19.8 / 8.0	2.3 / 0.8
M2A120RP945	12,000	M14 THD	4-1/2" x 1/4" wheel – Type 27	1.71 (3.76)	236 (9.29)		86 (3.39)	19.8 / 8.0	5.1 / 1.5
M2A120RP95	12,000	M14 THD	5" x 1/4" wheel – Type 27	1.77 (3.89)	236 (9.29)		86 (3.39)	19.8 / 8.0	5.0 / 0.9
M2A180RG4	18,000	Collet (6 mm & 1/4")	Burr	1.62 (3.56)	227 (8.94)		83 (3.28)	19.8 / 11.8	3.1 / 1.0
M2 SERIES STRAIGHT GRINDERS									
M2H180RG4	18,000	Collet (6 mm & 1/4")	Burr	0.77 (1.69)	213 (8.38)		NA	19.8 / 6.6	4.2 / 1.6
M2H200RG4	20,000	Collet (6 mm & 1/4")	Burr	0.77 (1.69)	213 (8.38)		NA	19.8 / 8.0	4.4 / 1.1
M2H250RG4	25,000	Collet (6 mm & 1/4")	Burr	0.77 (1.69)	213 (8.38)		NA	19.8 / 11.8	< 2.5
M2 SERIES EXTENDED STRAIGHT GRINDERS									
M2X180RH63	18,000	3/8"-24 THD	3" x 1/2" wheel – Type 1	1.48 (3.26)	339 (13.35)		NA	19.8 / 6.6	< 2.5
M2X075RG4	7,500	Collet (6 mm & 1/4")	Sanding drum (Mounted)	1.35 (2.97)	304 (11.95)		NA	19.8 / 11.8	< 2.5
M2X180RG4	18,000	Collet (6 mm & 1/4")	Burr	1.22 (2.68)	332 (13.08)		NA	19.8 / 6.6	2.8
M2X200RG4	20,000	Collet (6 mm & 1/4")	Burr	1.22 (2.68)	332 (13.08)		NA	19.8 / 8.0	< 2.5
M2X250RG4	25,000	Collet (6 mm & 1/4")	Burr	1.22 (2.68)	332 (13.08)		NA	19.8 / 11.8	< 2.5
M2 SERIES EXTENDED ANGLE SANDERS									
M2L055RS9	5,500	M14 THD	Sanding pad	1.90 (4.18)	318 (12.52)		91 (3.57)	19.8 / 11.8	3.7
M2L040RS9	4,000	M14 THD	Sanding pad	1.90 (4.18)	318 (12.52)		91 (3.57)	19.8 / 6.6	2.8
M2L025RS9	2,500	M14 THD	Sanding pad	1.90 (4.18)	318 (12.52)		91 (3.57)	19.8 / 8.0	4.0



M2X075RG4



M2X180RH63



M2L040RS9

G3 Series



G3A100RP106



G3X180RH63

Model	hp	rpm	Exhaust	Output	Type	lb (kg)	in (mm)	in (mm)	cfm
G-SERIES ANGLE GRINDERS									
G3A100RP106	1.35	10,000	Rear	5/8" – 11 thread, 6" guard	27, 28	4.9 (2.2)	9.6" (244)	3.6" (91)	33
G3A120RG4	1.35	12,000	Rear	1/4" collet	N/A	3.7 (1.6)	9.5" (241)	3.3" (84)	55
G3A120RP1045	1.35	12,000	Rear	5/8" – 11 thread, 4.5" guard	27, 28	4.6 (2)	9.6" (244)	3.6" (91)	55
G3A120RP105	1.35	12,000	Rear	5/8" – 11 thread, 5" guard	27, 28	4.7 (2.1)	9.6" (244)	3.6" (91)	55
G-SERIES HORIZONTAL GRINDERS									
G3H150RG4	1.35	15,000	Rear	1/4" collet	N/A	2.3 (1)	9.1" (231)	N/A	33
G3H180RG4	1.35	18,000	Rear	1/4" collet	N/A	2.3 (1)	9.1" (231)	N/A	55
G-SERIES EXTENDED ANGLE SANDERS									
G3L086RS10	1.35	8,600	Rear	5/8" – 11 thread	N/A	4.3 (1.9)	13.0" (330)	3.0" (76)	33
G-SERIES EXTENDED HORIZONTAL GRINDERS									
G3X150RG4	1.35	15,000	Rear	1/4" collet	N/A	3.7 (1.6)	14.1" (358)	N/A	33
G3X150RH64	1.35	15,000	Rear	3/8" – 24 thread, 4" guard	1	4.5 (2)	14.1" (358)	N/A	33
G3X180RG4	1.35	18,000	Rear	1/4" collet	N/A	3.7 (1.6)	14.1" (358)	N/A	55
G3X180RH63	1.35	18,000	Rear	3/8" – 24 thread, 3" guard	1	4.5 (2)	14.1" (358)	N/A	55

Air inlet for: G1, G2 – 1/4" NPT; G3 – 3/8" NPT
 Recommended hose size: G1, G2 – 3/8"; G3 – 1/2"
 Performance figures are at 90 psi air pressure.

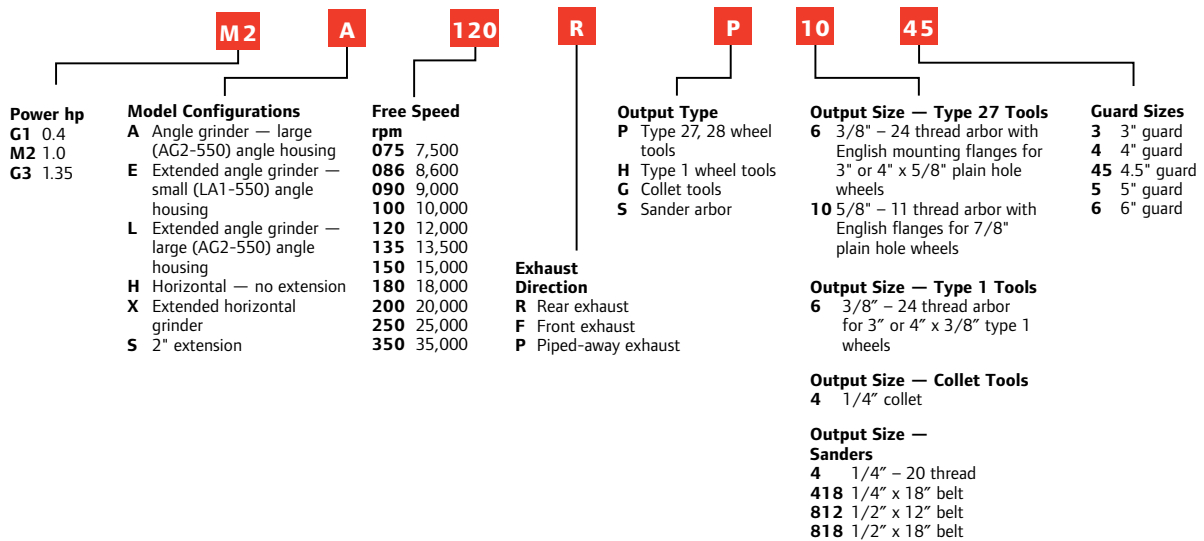

G-Series Grinder Accessories

Maintenance Kits

Part Number	For Use With
GRINDER TUNE-UP KITS	
AG1-TK1	G1 Series
	M2 Series
AG3-TK1	G3 Series



Part Number	Description	For Use With
G-SERIES GRINDERS EXTENDED WARRANTY KITS*		
AG1-XW1	Kit includes FRL, oil, grease, tune-up kit; extends standard 1-year warranty to 2-year coverage	G1 Series
AG2-XW1	Kit includes FRL, oil, grease, tune-up kit; extends standard 1-year warranty to 2-year coverage	M2 Series
AG3-XW1	Kit includes FRL, oil, grease, tune-up kit; extends standard 1-year warranty to 2-year coverage	G3 Series

*Purchase a warranty kit with a G-Series grinder and receive a full 2-year extended warranty.



Accessories

Description	G1 Series	G2 & G3 Series
2" abrasive kit	LG1-K2	N/A
3" abrasive kit	LG1-K3	N/A
Pad nut spanner	AG230-26M	AG230-26M
Combination wrench 1/2" – 9/16"	DG10-69	N/A
Combination wrench 7/16" – 11/16"	N/A	DG20-69A

Piped-Away Exhaust Kits

Part Number	For Use With
REAR EXHAUST KITS	
LG1-K284	G1 Series
	M2 Series
AG3-K284	G3 Series



Collets

Part Number	Size	Description
TAPPER COLLETS		
2U-103-1/4	1/4"	Tappers
4U-103-1/2	1/2"	Tappers



DIE GRINDER COLLETS		
DG110-700-6MM	6 mm	Metric die grinder
DG110-700-G2	1/8"	Die grinder
DG110-700-G4	1/4"	Die grinder
DG120-700-G6	3/8"	Die grinder
G160HD-700-1/4	1/4"	Die and horizontal grinders



DG110-700-6MM



DG110-700-G2



DG120-700-G6



G160HD-700-1/4

HORIZONTAL GRINDER COLLET BODY ASSEMBLIES		
RO-A390-1/4	1/4"	Collet adapter for wheel grinder models ending in H63 and H64
DG220-A290-G4	1/4"	Replacement collet body assembly for grinder models ending in G4, except C Series and G1 Series
DG220-A290-G6	3/8"	Replacement collet body assembly for grinder models ending in G6



RO-A390-1/4



DG220-A290-G6

COLLET WRENCHES	
DG20-69A	11/16" x 7/16"
DG120-69	5/8" x 3/4"



Revolution Series Grinders



Ingersoll Rand Revolution Series die grinders are designed for non-production, industrial applications and deliver high performance at an affordable price. These grinders epitomize the Ingersoll Rand tradition of quality engineering with light-weight, ergonomic designs that make tools comfortable and easy to use for material removal and surface preparation. Tools are available in a variety of configurations including straight, extended, and angle. Tools are also designed around various motor packages — offering different speeds and horsepower — providing the user with the optimal combination of die grinder performance to accomplish the task at hand.



Power

Powerful 0.33 to 0.40 hp air motors deliver plenty of strength in speeds from 12,000 to 35,000 rpm. The Revolution Series offers the torque and muscle required for a wide range of applications.

- Automotive
- General assembly
- Metal fabrication
- Plant maintenance
- Production prep
- Aerospace
- Shipbuilding
- Utilities
- Tool and die

Performance

Precision gearing and components contribute to long and reliable tool life. Whether removing material, weld cleaning, deburring, cutting, blending, grinding, sanding, or polishing, the New Revolution Series offers smooth operation, maximum power, and efficient performance, all at an affordable price.

Comfort

Weighing only 0.9 to 1.4 pounds, the New Revolution Series grinders requires minimal operator effort. Its compact, contoured shape fits naturally in the operator's hand for easy handling and maneuverability. A composite surface area covering the polished aluminum housing provides excellent grip and control, while insulating the operator from the effects of temperature and vibration.

Revolution Series grinders feature both ergonomic designs and light weight that make them comfortable and easy to use for material removal and surface preparation.



312AC4A



335SC4A



325XC4A

Model	hp	rpm	Exhaust	Output	lb (kg)	in (mm)	in (mm)	in (mm)	cfm
ANGLE									
312AC4A	0.40	12,000	Rear	1/4" collet	1.2 (0.55)	6.7" (170)	2.53" (64)	0.75" (19)	32
314AC4A	0.33	14,000	Rear	1/4" collet	1.2 (0.55)	6.7" (170)	2.53" (64)	0.75" (19)	30
320AC4A	0.40	20,000	Rear	1/4" collet	1.2 (0.55)	6.7" (170)	2.53" (64)	0.75" (19)	32
STRAIGHT									
325SC4A	0.40	25,000	Rear	1/4" collet	0.9 (0.43)	6.5" (166)	N/A	0.75" (19)	32
330SC4A	0.33	30,000	Rear	1/4" collet	0.9 (0.43)	6.5" (166)	N/A	0.75" (19)	30
335SC4A	0.37	35,000	Rear	1/4" collet	0.9 (0.43)	6.5" (166)	N/A	0.75" (19)	30
EXTENDED									
325XC4A	0.40	25,000	Rear	1/4" collet, 3" extended	1.4 (0.62)	9.6" (244)	N/A	0.75" (19)	33
330XC4A	0.33	30,000	Rear	1/4" collet, 3" extended	1.4 (0.62)	9.6" (244)	N/A	0.75" (19)	30

Air inlet for all models is 1/4" NPT.
 All models are rear exhaust.
 3/8" air hose recommended.
 Performance figures are at 90 psi air pressure.

See page 17 for abrasives.



M30TiN

This 30-piece, carbide burr mega-set covers a wide range of applications. Handy storage box keeps burrs organized and ready for use.

Quick Change Abrasives

Ingersoll Rand offers a complete line of 1-1/2" to 3" surface-conditioning discs designed to maximize the productivity of our air grinders, while ensuring the best possible finishes.

Quick Change Backer Pads

Part Number	Description
QUICK CHANGE BACKER PADS	
02A-MEDPD-NM	2" medium pad, no mandrel
03A-MEDPD-NM	3" medium pad, no mandrel
02A-SFTPD	2" soft holder pad with 1/4" mandrel
03A-SFTPD	3" soft holder pad with 1/4" mandrel
15A-MEDPD	1-1/2" medium holder pad with 1/4" mandrel
02A-MEDPD	2" medium holder pad with 1/4" mandrel
03A-MEDPD	3" medium holder pad with 1/4" mandrel
02A-FRMPD	2" firm holder pad with 1/4" mandrel
03A-FRMPD	3" firm holder pad with 1/4" mandrel



AO Series

FEATURES:	BENEFITS:
Quick change fastening systems	<ul style="list-style-type: none"> ▶ Instant disc changes ▶ Disc is centered ▶ Smooth-running
Multiple layers of backing	▶ Works well on flat and contoured surfaces
Aggressive stock removal	▶ Greater productivity

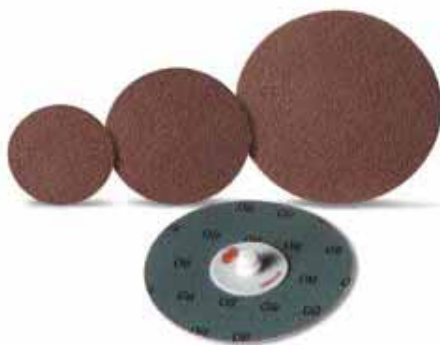

Industrial boxes come in 3 sizes

AO Series Quick Change Sanding Discs

Part Number	Description	Grit
INDUSTRIAL PACKS (FLIP-TOP BOX)		
15A-036AO-100	1-1/2" AO Series sanding disc	36
15A-050AO-100	1-1/2" AO Series sanding disc	50
15A-080AO-100	1-1/2" AO Series sanding disc	80
15A-120AO-100	1-1/2" AO Series sanding disc	120
15A-180AO-100	1-1/2" AO Series sanding disc	180
15A-240AO-100	1-1/2" AO Series sanding disc	240
02A-036AO-100	2" AO Series sanding disc	36
02A-050AO-100	2" AO Series sanding disc	50
02A-080AO-100	2" AO Series sanding disc	80
02A-120AO-100	2" AO Series sanding disc	120
02A-180AO-100	2" AO Series sanding disc	180
02A-240AO-100	2" AO Series sanding disc	240
03A-036AO-50	3" AO Series sanding disc	36
03A-050AO-50	3" AO Series sanding disc	50
03A-080AO-50	3" AO Series sanding disc	80
03A-120AO-50	3" AO Series sanding disc	120
03A-180AO-50	3" AO Series sanding disc	180
03A-240AO-50	3" AO Series sanding disc	240
02A-036AO-25	2" AO Series sanding disc	36
02A-050AO-25	2" AO Series sanding disc	50
02A-080AO-25	2" AO Series sanding disc	80
02A-120AO-25	2" AO Series sanding disc	120
02A-180AO-25	2" AO Series sanding disc	180
02A-240AO-25	2" AO Series sanding disc	240
03A-036AO-25	3" AO Series sanding disc	36
03A-050AO-25	3" AO Series sanding disc	50
03A-080AO-25	3" AO Series sanding disc	80
03A-120AO-25	3" AO Series sanding disc	120
03A-180AO-25	3" AO Series sanding disc	180
03A-240AO-25	3" AO Series sanding disc	240

Quick Change Abrasives (cont'd)

ZR Series Quick Change Sanding Discs

FEATURES:	BENEFITS:
Variety of quick change fastening systems	<ul style="list-style-type: none"> ▶ Instant disc changes ▶ Disc is centered ▶ Smooth-running
Zirconia alumina grain	<ul style="list-style-type: none"> ▶ Durable ▶ Rapid stock removal
Cooler-running	<ul style="list-style-type: none"> ▶ Reduces risk of loading ▶ Longer-lasting
2-ply construction	▶ Works well on flat or contoured surfaces

Part Number	Description	Grit
ZR SERIES — QUICK CHANGE SANDING DISCS		
15A-036ZR-100	1-1/2" ZR Series sanding disc	36
15A-050ZR-100	1-1/2" ZR Series sanding disc	50
15A-080ZR-100	1-1/2" ZR Series sanding disc	80
15A-120ZR-100	1-1/2" ZR Series sanding disc	120
02A-036ZR-100	2" ZR Series sanding disc	36
02A-050ZR-100	2" ZR Series sanding disc	50
02A-080ZR-100	2" ZR Series sanding disc	80
02A-120ZR-100	2" ZR Series sanding disc	120
03A-036ZR-50	3" ZR Series sanding disc	36
03A-050ZR-50	3" ZR Series sanding disc	50
03A-080ZR-50	3" ZR Series sanding disc	80
03A-120ZR-50	3" ZR Series sanding disc	120
02A-036ZR-25	2" ZR Series sanding disc	36
02A-050ZR-25	2" ZR Series sanding disc	50
02A-080ZR-25	2" ZR Series sanding disc	80
02A-120ZR-25	2" ZR Series sanding disc	120
03A-036ZR-25	3" ZR Series sanding disc	36
03A-050ZR-25	3" ZR Series sanding disc	50
03A-080ZR-25	3" ZR Series sanding disc	80
03A-120ZR-25	3" ZR Series sanding disc	120

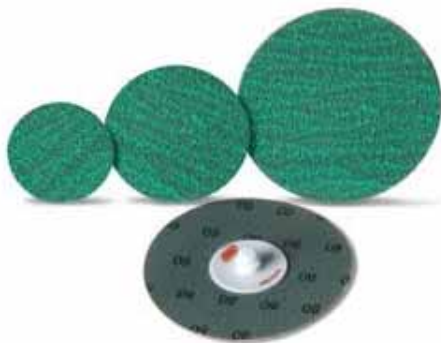

CO Series Quick Change Sanding Discs

FEATURES:	BENEFITS:
Ceramic grain	<ul style="list-style-type: none"> ▶ Durable ▶ Rapid stock removal
Stiff, durable backing	▶ Maintains high cut rate on edges without grain shredding and tearing
Cooler-running	▶ Reduces risk of loading

Part Number	Description	Grit
CO SERIES — QUICK CHANGE SANDING DISCS		
15A-036CO-100	1-1/2" CO Series sanding disc	36
15A-050CO-100	1-1/2" CO Series sanding disc	50
15A-080CO-100	1-1/2" CO Series sanding disc	80
15A-120CO-100	1-1/2" CO Series sanding disc	120
02A-036CO-100	2" CO Series sanding disc	36
02A-050CO-100	2" CO Series sanding disc	50
02A-080CO-100	2" CO Series sanding disc	80
02A-120CO-100	2" CO Series sanding disc	120
03A-036CO-50	3" CO Series sanding disc	36
03A-050CO-50	3" CO Series sanding disc	50
03A-080CO-50	3" CO Series sanding disc	80
03A-120CO-50	3" CO Series sanding disc	120
02A-036CO-25	2" CO Series sanding disc	36
02A-050CO-25	2" CO Series sanding disc	50
02A-080CO-25	2" CO Series sanding disc	80
02A-120CO-25	2" CO Series sanding disc	120
03A-036CO-25	3" CO Series sanding disc	36
03A-050CO-25	3" CO Series sanding disc	50
03A-080CO-25	3" CO Series sanding disc	80
03A-120CO-25	3" CO Series sanding disc	120



Quick Change Surface Prep Discs

Part Number	Description
INDUSTRIAL PACKS (FLIP-TOP BOX)	
15A-CRSBR-50	1-1/2" surface prep disc — coarse, brown
15A-MEDBR-50	1-1/2" surface prep disc — medium, maroon
15A-VFNBR-50	1-1/2" surface prep disc — very fine, blue
02A-CRSBR-50	2" surface prep disc — coarse, brown
02A-MEDBR-50	2" surface prep disc — medium, maroon
02A-VFNBR-50	2" surface prep disc — very fine, blue
03A-CRSBR-25	3" surface prep disc — coarse, brown
03A-MEDBR-25	3" surface prep disc — medium, maroon
03A-VFNBR-25	3" surface prep disc — very fine, blue
02A-CRSBR-25	2" surface prep disc — coarse, brown
02A-MEDBR-25	2" surface prep disc — medium, maroon
02A-VFNBR-25	2" surface prep disc — very fine, blue
03A-CRSBR-10	3" surface prep disc — coarse, brown
03A-MEDBR-10	3" surface prep disc — medium, maroon
03A-VFNBR-10	3" surface prep disc — very fine, blue



Quick Change Quick Strip Discs

Part Number	Description
02A-CRSBS-25	2" surface prep coating removal disc — black
03A-CRSBS-10	3" surface prep coating removal disc — black
02A-CRSBB-25	2" surface prep coating removal disc — blue
03A-CRSBB-10	3" surface prep coating removal disc — blue
02A-CRSBS-10	2" surface prep coating removal disc — black
03A-CRSBS-5	3" surface prep coating removal disc — black
02A-CRSBB-10	2" surface prep coating removal disc — blue
03A-CRSBB-5	3" surface prep coating removal disc — blue
TEST KIT	
23A-VAR-GR	50-piece accessory kit



High Strength Buffing Discs

Part Number	Description
INDUSTRIAL PACKS (FLIP-TOP BOX)	
02A-MEDBB-50	2" quick change buffing disc — medium
03A-MEDBB-25	3" quick change buffing disc — medium
02A-MEDBB-25	2" quick change buffing disc — medium
03A-MEDBB-10	3" quick change buffing disc — medium



Quick Change Abrasives (cont'd)

Abrasive Convenience Packs

Part Number	Description
GRINDING AND CUTTING (6-PIECE VARIETY GRIT PACKS)	
02A-VARAO-6	2" AO Series sanding discs — 2 each 36, 50, 80 grit
03A-VARAO-6	3" AO Series sanding discs — 2 each 36, 50, 80 grit
02A-VARCO-6	2" CO Series sanding discs — 2 each 36, 50, 80 grit
03A-VARCO-6	3" CO Series sanding discs — 2 each 36, 50, 80 grit
23A-VARAO-6	2" and 3" AO Series sanding discs — 1 each 36, 50, 80 grit
SURFACE CONDITIONING/GASKET REMOVAL (VARIETY GRIT PACKS)	
02A-VARBR-5	2" surface preparation discs — 2 each coarse and medium, 1 very fine
03A-VARBR-5	3" surface preparation discs — 2 each coarse and medium, 1 very fine
23A-VARBR-6	2" and 3" surface preparation discs — 1 each 36, 50, 80 grit
HIGH STRENGTH — BLENDING AND BUFFING DISCS	
02A-MEDHS-3	2" medium-grade, high-strength blending kit
03A-MEDHS-4	3" medium-grade, high-strength blending kit
QUICK STRIP — PAINT AND CORROSION DISCS	
2A-CRSBS-4	2" coarse quick-strip kit
03A-CRSBS-4	3" coarse quick-strip kit
COMPLETE SURFACE CONDITIONING KITS	
02A-VAR-KIT	2" complete surface preparation kit
03A-VAR-KIT	3" complete surface preparation kit



Abrasive Convenience Packs

Part Number	Description
9520	3" diameter cutting discs (5 pack)
9521	3" diameter cutting discs (50 pack)

Carbide Burrs

Ingersoll Rand carbide burrs set the industry standard for quality and are the perfect complement to our innovative grinders and finishing tools. You'll find a complete range of versatile, durable, high-precision burrs, in a variety of types and sizes.

Cylindrical-shaped Burrs

Part Number	Type of Cut	Shank	Length of Cut
1/8" CYLINDRICAL-SHAPED BURR*			
IRSA-11	Super cut	1/4"	1/2"
1/4" CYLINDRICAL-SHAPED BURRS*			
IRSA-1	Super cut	1/4"	5/8"
IRSA-1L	Super cut	1/4"	1"
5/16" CYLINDRICAL-SHAPED BURRS**			
IRSA-2	Super cut	1/4"	3/4"
IRSA-2F	Fine cut	1/4"	3/4"
3/8" CYLINDRICAL-SHAPED BURRS**			
IRSA-3	Super cut	1/4"	3/4"
IRSA-3F	Fine cut	1/4"	3/4"
1/2" CYLINDRICAL-SHAPED BURRS**			
IRSA-5	Super cut	1/4"	1"
IRSA-5EC	Super end cut	1/4"	1"
IRSA-5F	Fine cut	1/4"	1"
1/4" CYLINDRICAL-SHAPED BURR (RADIUS NOSE)*			
IRSC-1	Super cut	1/4"	1"

*Solid carbide burr.

**Solid carbide burr with steel shank.

Cone-shaped Burrs (radius nose)



Part Number	Type of Cut	Shank	Length of Cut
5/16" CONE-SHAPED BURRS (RADIUS NOSE)*			
IRSL-2	Super cut	1/4"	3/4"
3/8" CONE-SHAPED BURRS (RADIUS NOSE)			
IRSL-3	Super cut	1/4"	3/8"

*Solid carbide burr with steel shank.

Ball-shaped Burrs



Part Number	Type of Cut	Shank	Length of Cut
1/4" BALL-SHAPED BURRS*			
IRSD-1	Super cut	1/4"	1/4"
IRSD-3	Super cut	1/4"	3/8"

*Solid carbide burr with steel shank.

Tree-shaped Burrs



Part Number	Type of Cut	Shank	Length of Cut
1/4" TREE-SHAPED (POINTED NOSE)*			
IRSF-1	Super cut	1/4"	5/8"
3/8" TREE-SHAPED (POINTED NOSE)**			
IRSF-3	Super cut	1/4"	3/4"
1/2" TREE-SHAPED (POINTED NOSE)**			
IRSF-5	Super cut	1/4"	1"
5/16" TREE-SHAPED (RADIUS NOSE)**			
IRSG-2	Fine cut	1/4"	3/4"

*Solid carbide burr.

**Solid carbide burr with steel shank.

Carbide Burrs (cont'd)

Carbide Grinding Burr Kits

Ingersoll Rand carbide burrs are titanium nitride (TiN) coated to provide maximum edge retention and corrosion resistance. The TiN coating can improve the average lifetime of the burr by more than three times.

Note: Burrs have a maximum operating speed of 40,000 rpm.

Part Number	Description	
1814TiN	6-piece carbide burr kit	TiN coated carbide burrs — 1/8" shank, 1/4" head diameter with soft-sided case
618TiN	6-piece carbide burr kit	TiN coated carbide burrs — 1/8" shank, 1/4" and 1/8" head diameters with soft-sided case
1818TiN	6-piece carbide burr kit	TiN coated carbide burrs — 1/8" shank, 1/8" head diameter with soft-sided case
1816TiN	6-piece carbide burr kit	TiN coated carbide burrs — 1/8" shank, various head diameters with soft-sided case
1438TiN	6-piece carbide burr kit	TiN coated carbide burrs — 1/4" shank, 3/8" head diameter with soft-sided case
614TiN	6-piece carbide burr kit	TiN coated carbide burrs — 1/4" shank, 1/2" and 3/8" head diameters with soft-sided case
1412TiN	6-piece carbide burr kit	TiN coated carbide burrs — 1/4" shank, 1/2" head diameter with soft-sided case
M30TiN	30-piece carbide burr mega set	TiN coated carbide burrs — 1/4" and 1/2" shank, various head diameters and shapes with hard case
814TiN	8-piece carbide burr kit	TiN coated carbide burrs — 1/4" shank, 1/2" and 3/8" head diameter with hard case



1438TiN



1814TiN



M30TiN

This 30-piece, carbide burr mega-set covers a wide range of applications. Handy storage box keeps burrs organized and ready for use.

Sanding Pads/Belts

(straight, angle, and vertical grinders)

Sanding Pad Assemblies

Part Number	Description	For Use With
SANDING PAD ASSEMBLIES (MEDIUM)		
77A-AM825-5	5" sanding pad assembly	G2 Series, ErgoPro Series, Pro-Series
77A-AM825-7	7" sanding pad assembly	G2 Series, ErgoPro Series, Pro-Series
SANDING PAD ASSEMBLY (FIRM)		
77A-AM825-9	9" sanding pad assembly	G2 Series, ErgoPro Series, Pro-Series
313A-226	Pad nut	G2 Series grinders Pro-Series



Sanding pad assembly (medium)



Sanding pad assembly (firm)

Sanding Belts

Part Number	Description	Grit	For Use With
1/4" x 18" SANDING BELTS			
LG1-SB418-60-10	Pack of 10 sanding belts	60	G1A120RS418, G1A200RS418
LG1-SB418-80-10	Pack of 10 sanding belts	80	G1A120RS418, G1A200RS418
LG1-SB418-100-10	Pack of 10 sanding belts	100	G1A120RS418, G1A200RS418
1/2" x 12" SANDING BELTS			
LG1-SB812-60-10	Pack of 10 sanding belts	60	G1A120RS812, G1A200RS812
LG1-SB812-80-10	Pack of 10 sanding belts	80	G1A120RS812, G1A200RS812
LG1-SB812-100-10	Pack of 10 sanding belts	100	G1A120RS812, G1A200RS812
1/2" x 18" SANDING BELTS			
LG1-SB818-60-10	Pack of 10 sanding belts	60	G1A120RS818, G1A200RS818
LG1-SB818-80-10	Pack of 10 sanding belts	80	G1A120RS818, G1A200RS818
LG1-SB818-100-10	Pack of 10 sanding belts	100	G1A120RS818, G1A200RS818



1/4" x 18" sanding belts



1/2" x 12" sanding belts



1/2" x 18" sanding belts

Pro-Series™ Grinders



With the Pro-Series grinders, Ingersoll Rand offers a complete line of heavy-duty vertical, horizontal, and angle finishing tools that deliver superior performance, as well as outstanding safety and ergonomic features. Available in 1.25 to 3.0 hp motors, Pro-Series grinders are specially designed for heavy-duty production applications.

Pro-Series grinders reduce air consumption by one-third over competitive models, while removing up to 25 percent more material. When it comes to reliability and safety, no other grinders compare to the Pro-Series. They feature best-in-class vibration dampening, patented integral guards, and self-locking throttle levers to prevent accidental operation.

Motor Controller

Ingersoll Rand Pro-Series finishing tools incorporate a patented motor controller designed to increase productivity while enhancing operator safety. The controller regulates airflow through the endplate and into the motor to control the speed and power of the tool. There is no need for an additional over-speed shut-off device.



Locking Throttle Lever

The Ingersoll Rand locking throttle lever is a spring-loaded latch that resets each time the lever is released. This unique system prevents accidental throttle operation — even if the tool is dropped.



Integral Guards

Pro-Series grinders are equipped with patented integral guards that prevent the tool from operating if they are removed. When removed, the tool's motor is not properly supported, and the tool will not operate. Cup-type grinding tools have the exclusive Ingersoll Rand 180° integral guard for better visibility and greater wheel usage. All guards are made of steel for extra protection.



The unique motor controller design of the Pro-Series increases productivity while enhancing operator safety.

Pro-Series 88 and 99

- Powerful 2 hp and 3 hp motors for efficient high performance.
- Patented stainless-steel motor controller with industry's only lifetime guarantee.
- Self-locking throttle lever prevents accidental operation.
- Integral steel guard provides extra strength for added operator protection.
- Four-position exhaust adds to operator comfort on horizontal models.



Pro-Series 77

- Powerful 1.5 hp motor produces efficient high performance.
- Patented stainless-steel motor controller with industry's only lifetime guarantee.
- Self-locking throttle lever prevents accidental operation.
- Integral steel guard provides extra strength for added operator protection.
- Low-profile angle head improves close-quarter applications.



Pro-Series 61

- Solid steel motor and arbor housing provide maximum durability.
- Powerful 1.25 to 1.33 hp motor produces efficient high performance.
- Patented stainless-steel motor controller is maintenance- and adjustment-free.
- Heavy-duty, double-row ball bearings assure long life and smooth operation.
- Exclusive grit-rejection system keeps motor and bearings clean for extended life.
- Built-in mist lubricator automatically oils motor when throttle is activated.



Series	Type	Throttle	Free Speed rpm	Type of Wheel	Diameter and Thread of Arbor	Diameter of Collet or Wheel
61	A Angle	L Lever	45 4,500	G Collet	6 3/8" – 24 thread	4 1/4" collet
77	H Horizontal	G Grip	60 6,000	H Type 1 wheel	8 1/2" – 13 thread	3 3" wheel
88	V Vertical		77 7,700	L Cone wheel	10 5/8" – 11 thread	4 4" wheel
99			90 9,000	P Type 27 wheel		6 6" wheel
			120 12,000	S Type 11 wheel		7 7" wheel
			150 15,000			8 8" wheel
						9 9" wheel

Straight Grinders

Carbide Burr and Mounted Wheel

Standard Equipment

- G160HD-700-1/4 1/4" Erickson collet
- DG10-69 collet body wrench
- DG120-69 collet nut wrench

Accessories

- DG120-700-G6 3/8" collet



61H120G4

Model	hp	rpm	Exhaust	Output	lb (kg)	in (mm)	Spindle Housing Diameter in (mm)	cfm
61H120G4	1.25	12,000	Side	1/4" Collet	4.3 (1.9)	15.5" (393)	1.4" (36)	37
61H150G4	1.33	15,000	Side	1/4" Collet	4.3 (1.9)	15.5" (393)	1.4" (36)	40

Air inlet for both models is 3/8".
Size hose recommended for both models is 1/2".
Performance figures are at 90 psi air pressure.

Cone and Plug Wheel

Standard Equipment

- Tool wrench



61H120L6



88HL90L10

Model	hp	rpm	Exhaust	Output	lb (kg)	in (mm)	Spindle Housing Diameter in (mm)	cfm
61H120L6	1.25	12,000	Side	3/8" - 24 Thread	4.3 (1.9)	14.8" (376)	1.4" (36)	37
61H150L6	1.33	15,000	Side	3/8" - 24 Thread	4.3 (1.9)	14.8" (376)	1.4" (36)	40
77H90L10	1.5	9,000	Side	5/8" - 11 Thread	6.0 (2.7)	16.4" (417)	1.9" (48)	37
77H120L10	1.5	12,000	Side	5/8" - 11 Thread	6.0 (2.7)	16.4" (417)	1.9" (48)	39
88HL90L10	2.2	9,000	Side	5/8" - 11 Thread	8.4 (3.8)	18.3" (465)	2.3" (58)	66

Air inlet for Series 88H is 1/2" NPT. All others 3/8" NPT.
Size hose recommended for Series 88H is 3/4". All others 1/2".
Performance figures are at 90 psi air pressure.
Maximum wheel diameter is 3".

Straight Grinders (cont'd)

Type 1 Wheel

Standard Equipment

- Wheel guard, flanges, and nut

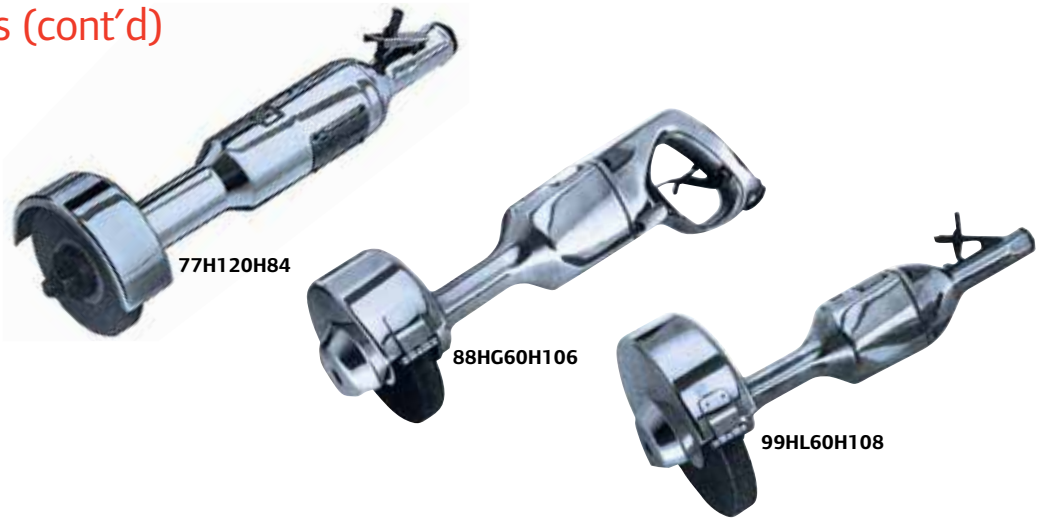

Model	Handle	hp	rpm	Exhaust	Output	lb (kg)	in (mm)	Spindle Housing Diameter	in (mm)	cfm
61H120H63	Lever	1.25	12,000	Side	3/8" – 24 Thread, 3" guard	4.8" (2.2)	15.8" (401)	1.4" (36)	3" x 1/2" (75 x 13)	37
61H120H64	Lever	1.25	12,000	Side	3/8" – 24 Thread, 4" guard	4.8" (2.2)	15.8" (401)	1.4" (36)	4" x 1/2" (100 x 13)	37
61H150H63	Lever	1.33	15,000	Side	3/8" – 24 Thread, 3" guard	4.8" (2.2)	15.8" (401)	1.4" (36)	3" x 1/2" (75 x 13)	40
77H120H63	Lever	1.5	12,000	Side	3/8" – 24 Thread, 3" guard	6.1" (2.8)	16.6" (422)	2.6" (66)	3" x 1/2" (75 x 13)	39
77H90H84	Lever	1.5	9,000	Side	1/2" – 13 Thread, 4" guard	6.5" (2.9)	17.3" (439)	2.6" (66)	4" x 1" (100 x 25)	37
77H120H84	Lever	1.5	12,000	Side	1/2" – 13 Thread, 4" guard	6.5" (2.9)	17.3" (439)	2.6" (66)	4" x 1" (100 x 25)	39
88HL60H106*	Lever	2	6,000	Side	5/8" – 11 Thread, 6" guard	11.3" (5.1)	20.0" (508)	3.4" (86)	6" x 1" (150 x 25)	61
88HG60H106*	Grip	2	6,000	Side	5/8" – 11 Thread, 6" guard	11.7" (5.3)	19.8" (503)	3.4" (86)	6" x 1" (150 x 25)	61
99HL60H106*	Lever	3	6,000	Side	5/8" – 11 Thread, 6" guard	13.5" (6.1)	20.5" (520)	3.9" (99)	6" x 1" (150 x 25)	84
99HG60H106*	Grip	3	6,000	Side	5/8" – 11 Thread, 6" guard	15.3" (6.9)	20.4" (518)	3.9" (99)	6" x 1" (150 x 25)	84
99HL45H108**	Lever	2.35	4,500	Side	5/8" – 11 Thread, 8" guard	14.9" (6.8)	20.3" (516)	3.9" (99)	8" x 1" (203 x 25)	70
99HG45H108**	Grip	2.35	4,500	Side	5/8" – 11 Thread, 8" guard	15.6" (7.1)	20.1" (511)	3.9" (99)	8" x 1" (203 x 25)	70
99HL60H108**	Lever	3	6,000	Side	5/8" – 11 Thread, 8" guard	14.8" (6.7)	20.3" (516)	3.9" (99)	8" x 1" (203 x 25)	84

*Net weight of guard and flanges is 3.2 lb.

**Net weight of guard and flanges is 4.5 lb.

Air inlet for Series 61H and 77H is 3/8" NPT. For Series 88H and 99H, 1/2" NPT.

Size hose recommended for Series 61H and 77H is 1/2". For Series 88H and 99H, 3/4".

Performance figures are at 90 psi air pressure.

Angle Grinders

Depressed Center Wheel Type 27 and 28 Wheel

Standard Equipment

- Wheel guard, flanges, and nut for threaded and plain depressed center wheels

Accessories

- Piped-away exhaust kit 88V60-K184 (for 88V)
- Piped-away exhaust kit 99V60-K184 (for 99V)



77A60P107



88V60P107

Model	hp	rpm	Exhaust	Output	lb (kg)	in (mm)	in (mm)	in (mm)	in (mm)	m/s ²	cfm
ANGLE GRINDERS*											
77A60P107	1.5	6,000	Side	5/8" – 11 Thread, 7" guard	9.0 (4.1)	17.6" (447)	3.9" (99)	1.3" (33)	7" (177)	1.9	39
77A60P109	1.5	6,000	Side	5/8" – 11 Thread, 9" guard	9.2 (4.2)	17.6" (447)	3.9" (99)	1.3" (33)	9" (228)	1.8	39
77A75P107	1.5	7,500	Side	5/8" – 11 Thread, 7" guard	9.2 (4.2)	17.6" (447)	3.9" (99)	1.3" (33)	7" (177)	2	39
VERTICAL GRINDERS**											
88V60P107	2.1	6,000	Side	5/8" – 11 Thread, 7" guard	8.8 (4.0)	N/A	6.1" (155)	2.1" (54)	7" (177)	1.5	61
88V60P109	2.1	6,000	Side	5/8" – 11 Thread, 9" guard	9.1 (4.1)	N/A	6.1" (155)	2.1" (54)	9" (228)	1	61
88V77P107	2.2	7,700	Side	5/8" – 11 Thread, 7" guard	8.8 (4.0)	N/A	6.1" (155)	2.1" (54)	7" (177)	1.2	68
88V85P107	2.2	8,500	Side	5/8" – 11 Thread, 7" guard	8.8 (4.0)	N/A	6.1" (155)	2.1" (54)	7" (177)	1.5	66
99V60P107	3.0	6,000	Side	5/8" – 11 Thread, 7" guard	11.3 (5.1)	N/A	6.9" (175)	2.9" (74)	7" (177)	1.5	84
99V60P109	3.0	6,000	Side	5/8" – 11 Thread, 9" guard	11.3 (5.1)	N/A	6.9" (175)	2.9" (74)	9" (228)	0.9	84
99V77P107	3.0	7,700	Side	5/8" – 11 Thread, 7" guard	11.3 (5.1)	N/A	6.9" (175)	2.9" (74)	7" (177)	0.9	84
99V85P107	3.0	8,500	Side	5/8" – 11 Thread, 7" guard	11.3 (5.1)	N/A	6.9" (175)	2.9" (74)	7" (177)	0.9	84

*Air inlet for all models is 3/8" NPT.
Size hose recommended for all models is 1/2".

**Air inlet for all models is 1/2" NPT.
Size hose recommended for all models is 3/4".

Performance figures are at 90 psi air pressure.

Vertical Grinders

Cup Wheel Type 6 and 11 Wheel

Standard Equipment

- Wheel guard, flanges, and nut

Accessories

- For vertical grinder
- Piped-away exhaust kit 88V60-K184 (for 88V)
- Piped-away exhaust kit 99V60-K184 (for 99V)



88V60S106



99V60S106

Model	hp	rpm	Exhaust	Output	lb (kg)	in (mm)	in (mm)	in (mm)	m/s ²	cfm
88V60S106	2.1	6,000	Side	5/8"– 11 spindle, 6" guard	8.4 (3.8)	6.1" (155)	2.1" (53)	5" or 6" (127 or 152)	0.8	61
99V45S106	2.5	4,500	Side	5/8"– 11 spindle, 6" guard	10.8 (4.9)	6.9" (175)	2.9" (74)	5" or 6" (127 or 152)	1.1	70
99V60S106	3.0	6,000	Side	5/8"– 11 spindle, 6" guard	10.8 (4.9)	6.9" (175)	2.9" (74)	5" or 6" (127 or 152)	0.6	84

Air inlet for all models is 1/2" NPT.

Size hose recommended for all models is 3/4".

Performance figures are at 90 psi air pressure.

Pro Series Grinder Accessories

Collet Accessories

Description	Series 61H	Series 77H	Series 88H
1/4" Erickson collet	G160-HD-700-1/4	N/A	N/A
1/4" Erickson collet assembly	DG220-A290-G4	N/A	N/A
3/8" Erickson collet	DG120-700-G6	N/A	N/A
3/8" Erickson collet assembly	DG220-A290-G6	N/A	N/A
Collet body wrench	DG10-69	N/A	N/A
Collet nut wrench	DG120-69	N/A	N/A
3/8"-24 cone wheel spindle	DG220-104-L6	N/A	N/A
Cone wheel spindle wrench	DG20-69A	7RAQT4-254	7RAQT4-254
Controller wrench	R15-169	77H-950	88V60-950

Type 27 and 28 Wheel Accessories

Description	Series 77A	Series 88V	Series 99V
6" type 6 or 11 cup wheel guard	N/A	88V60-A216	99V60-A216A
Piped-away exhaust kit	N/A	88V60-K184	99V60-K184
Wheel retaining screw wrench	88V-562	88V-562	88V-562
Controller wrench	77H-950	88V60-950	99V60-950

Type 6 and 11 Wheel Accessories

Description	Series 88V	Series 99V
7" type 27 wheel guard	88V60-106-7	99V77-106-7
9" type 27 wheel guard	88V60-106-9	99V60-106-9
7" and 9" type 27 wheel adapter kit*	R3F-AS337	R3F-AS337
Piped-away exhaust kit	88V60-K184	99V60-K184
Wheel retaining screw wrench	88V-562	88V-562
Controller wrench	88V60-950	99V60-950

*For use with Type 27 plain hole depressed center wheels.

Maintenance Kits

Part Number	For Use With
GRINDER TUNE-UP KITS	
61H-TK1	61H Series
66H-TK3	66H Series
77H/77A-TK3	77H and 77A Series
7560-TK2	7560L (Pro-Series grinder)
88V/88H-TK3	88V and 88H Series
99V/99H-TK3	99V and 99H Series

Pro-Series Finishing Tools

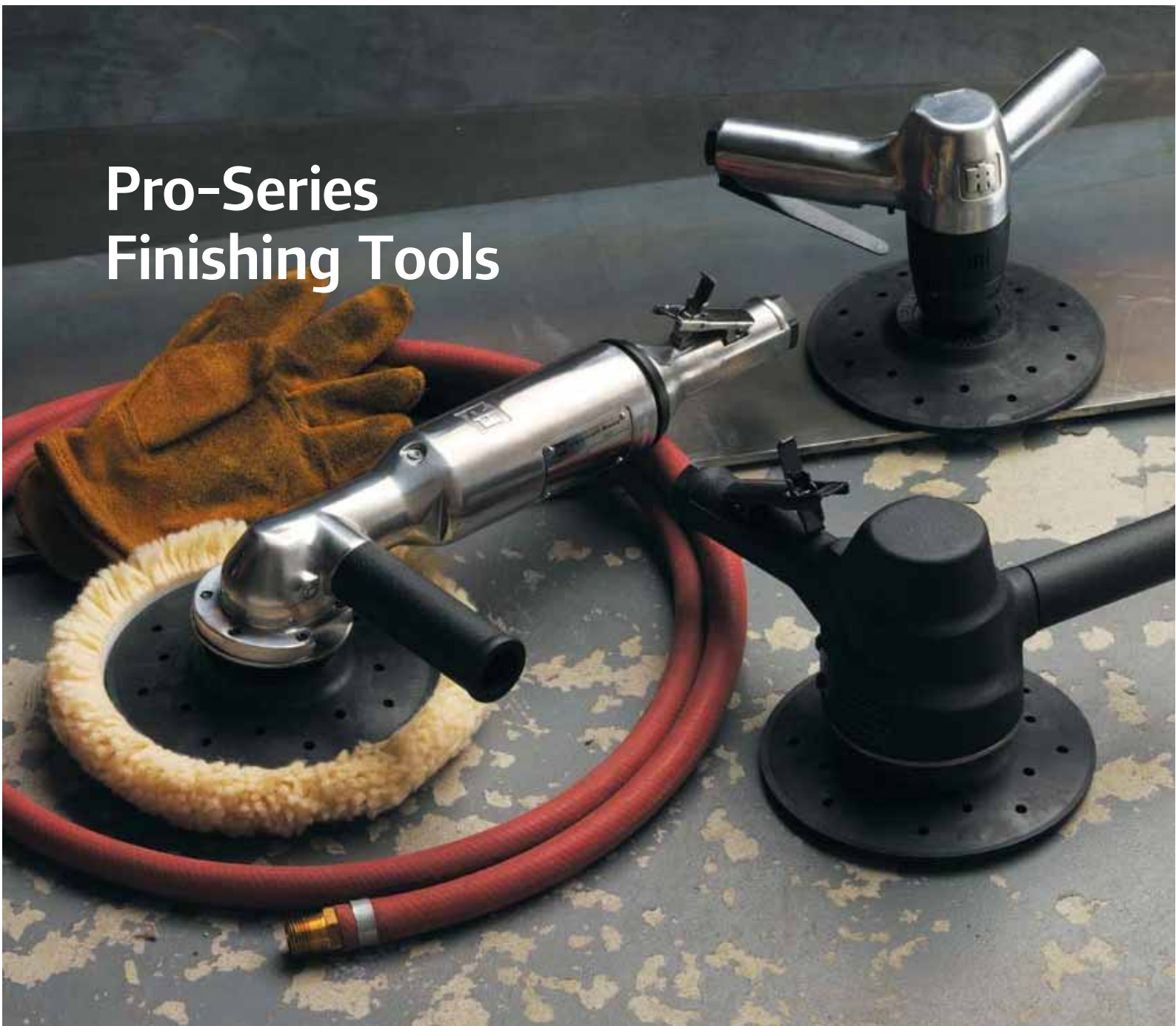

Ingersoll Rand industrial sanders, polishers, and buffers have been developed for specific use in surface preparation and final finishing applications. These models are multipurpose accessory tools used in aerospace, shipbuilding, utilities, woodworking, furniture production, vehicle and marine assembly, and general maintenance.

Pro-Series Sanders, Polishers, and Buffers

Designed for applications involving larger areas and heavier-duty materials, Pro-Series sanders, polishers, and buffers range from 0.8 to 3 horsepower, in straight, angle, and vertical configurations. They incorporate many of the same unique features as their counterpart grinder models.

Series	Type	Free Speed rpm	Type of Wheel	Arbor Diameter	Wheel Diameter
61	A Angle		B Wire brush	10 5/8" – 11 thread	6 6" wheel
77	H Horizontal	24 2,400	F Polishing head		7 7" wheel
88	S Vertical	25 2,500	W Sanding head		8 8" wheel
99	sander	30 3,000			9 9" wheel
		45 4,500			
		48 4,800			
		50 5,000			
		60 6,000			

Angle Tools

Pro-Series

Standard Equipment

- Back-up pads with nut
77A-BM825-7 – 7" firm (F107)
77A-AM825-9 – 9" medium (W109)
- P500-850 polishing bonnet
(model 77A25F107 only)

Accessories

- 77A-AM825-5 – 5" medium pad
- 77A-AM825-7 – 7" medium pad
- AG230-26M spanner



Model	hp	rpm	Exhaust	Output	lb (kg)	in (mm)	in (mm)	in (mm)	m/s ²	cfm
77A25F107	1.5	2,500	Side	5/8" – 11 Thread, 7" polishing bonnet	8.4 (3.8)	17.6" (447)	3.8" (97)	1.3" (33)	3.4	37
77A45W109	1.5	4,500	Side	5/8" – 11 Thread, 9" back-up pad	7.8 (3.5)	17.6" (447)	3.8" (97)	1.3" (33)	1.5	37
77A60W107	1.5	6,000	Side	5/8" – 11 Thread, 7" back-up pad	7.8 (3.5)	17.6" (447)	3.8" (97)	1.3" (33)	1.2	39

Air inlet for all models is 3/8" NPT.

Size hose recommended for all models is 1/2".

Performance figures are at 90 psi air pressure.

Vertical Tools

Pro-Series

Standard Equipment

- Backer pads
77A-AM825-7 – 7" medium pad
77A-AM825-9 – 9" pad



88S60W107

Accessories

- Comfort grips CG-88V, CG99V
- 77A-BM825-7 – 7" firm pad
- AG230-26M spanner
- AG230-26M spanner wrench
- Piped-away exhaust kits 88V60-K184, 99V60-K184

Model	hp	rpm	Exhaust	Output	lb (kg)	in (mm)	in (mm)	m/s ²	cfm
88S45W109	1.8	4,500	Side	5/8" – 11 Thread, 9" back-up pad	7.1 (3.2)	6.0" (152)	2.1" (53)	1	50
88S60W107	2.0	6,000	Side	5/8" – 11 Thread, 7" back-up pad	7.1 (3.2)	6.0" (152)	2.1" (53)	1	61
99S45W109	2.5	4,500	Side	5/8" – 11 Thread, 9" back-up pad	9.5 (4.3)	6.3" (160)	2.9" (74)	0.6	70
99S60W107	3.0	6,000	Side	5/8" – 11 Thread, 7" back-up pad	9.5 (4.3)	6.3" (160)	2.9" (74)	0.9	84

Air inlet for both models is 1/2" NPT. Size hose recommended for both models is 3/4". Performance figures are at 90 psi air pressure.

Pro-Series

Standard Equipment

- 77A-8M825-7 backer pad
- P500-850 polishing bonnet (model 7P24L only)



7S60L

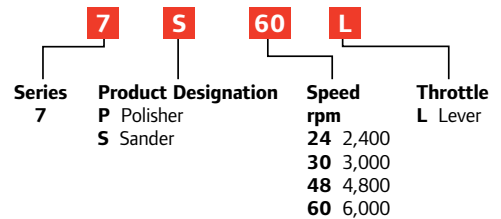

Model	hp	rpm	Exhaust	Output	without Pad lb (kg)	in (mm)	in (mm)	cfm
7P24L	0.8	2,400	Side	5/8" – 11 Thread, 7" polishing bonnet	3.3 (1.5)	6.4" (163)	0.4" (10)	22
7S30L	0.8	3,000	Side	5/8" – 11 Thread, 7" back-up pad	3.3 (1.5)	6.4" (163)	0.4" (10)	22
7S48L	0.8	4,800	Side	5/8" – 11 Thread, 7" back-up pad	3.3 (1.5)	6.4" (163)	0.4" (10)	22
7S60L	0.8	6,000	Side	5/8" – 11 Thread, 7" back-up pad	3.3 (1.5)	6.4" (163)	0.4" (10)	22

Air inlet for all models is 1/4" NPT. Size hose recommended for all models is 5/16". Performance figures are at 90 psi air pressure.

Straight Tools

Pro-Series

Standard Equipment

- Wheel, flanges, and nut

Accessories

- 7RAQT4-254 1" wheel bearing nut wrench
- 7S60-24818 wire brush nut wrench



77H30B106

Spindle is 2-3/4" long.
Threads are 2" long.

Model	hp	rpm	Exhaust	Output	lb (kg)	in (mm)	in (mm)	cfm
77H30B106	1.5	3,000	Side	5/8" – 11 x 2" Thread (for flap wheels, wire brushes, etc.)	7.3 (3.3)	17.7" (450)	0.9" (23)	37
77H50B106	1.5	5,000	Side	5/8" – 11 x 2" Thread (for flap wheels, wire brushes, etc.)	7.3 (3.3)	17.7" (450)	0.9" (23)	39

Air inlet for both models is 3/8" NPT. Size hose recommended for both models 1/2". Performance figures are at 90 psi air pressure.

Pro-Series Finishing Tool Accessories

Description	Series 7	Series 77A	Series 88S	Series 99S
5" medium sanding pad assembly	77A-AM825-5	77A-AM825-5	77A-AM825-5	77A-AM825-5
7" medium sanding pad assembly	77A-AM825-7	77A-AM825-7	77A-AM825-7	77A-AM825-7
7" firm sanding pad assembly	77A-BM825-7	77A-BM825-7	77A-BM825-7	77A-BM825-7
9" firm sanding pad assembly	77A-AM825-9	77A-AM825-9	77A-AM825-9	77A-AM825-9
7" wool polishing bonnet	P500-850	P500-850	N/A	N/A
Pad nut	D94SK-226	D94SK-226	D94SK-226	D94SK-226
Pad nut wrench	D94SK-26	D94SK-26	D94SK-26	D94SK-26
Spindle wrench	7S60-24818*	DG120-69	DG120-69	DG120-69**
Controller wrench	N/A	77H-950	88V60-950	99V60-950
Pad nut kit	77A-826	77A-826	77A-826	77A-826

*5/16" OE.

**5/8" x 3/4" OE.

Finishing Tools



Ingersoll Rand offers a host of finishing tools to accomplish a variety of surface preparation tasks, whether heavy-duty or intricate in nature. We provide an impressive line of scalers, needle scalers, piston scalers, drills, and accessories. For the smaller jobs, our ARO finishing tool line is the perfect solution — excellent for intricate grinding applications, including mold finishing, deburring, cleaning, and polishing.

Consult our website, your distributor, or an Ingersoll Rand representative for more details on our complete product line.

Pistol Grip Scalers



Model	Description	lb (kg)	in (mm)	in (mm)	in (mm)	bpm	in	in (mm)	No. of 3 mm Needles (flat)	cfm
170PG	Needle scaler	6.6 (3.0)	12.4" (314)	1.4" (35)	0.9" (23)	3,000	1/4" NPT	N/A	19	5.5
180PG	Needle scaler	8.9 (4.0)	13.5" (342)	1.5" (38)	1.1" (28)	2,200	1/4" NPT	N/A	28	8
170PG-CS	Chisel scaler	5.3 (2.4)	12.4" (314)	1.4" (35)	0.9" (23)	3,000	1/4" NPT	1/2" (12)	N/A	5.5
180PG-CS*	Chisel scaler	6.8 (3.1)	12.4" (314)	1.5" (38)	1.1" (28)	2,200	1/4" NPT	1/2" (12)	N/A	8

*5/8" hex shank chisel holder/retainer (p/n 22039705) is available for 180PG-CS

170PG-KIT includes: The 170PG needle scaler, the 1/2" shank chisel holder, 3 needle packs, and 3 chisels. Needles included are one pack each of chisel tip, pointed tip, and flat 3 mm needles. There are 19 needles per pack. The needles are 7" long and made of carbon steel. The chisels included are one each of the following 1/2" square, 7" long chisels: a 3/4" flat, a 1-3/8" offset (weld flux), and a 2" flat chisel.

180PG-KIT includes: The 180PG needle scaler, the 1/2" shank chisel holder, 3 needle packs, and 3 chisels. Needles included are one pack each of chisel tip, pointed tip, and flat 3 mm needles. There are 28 needles per pack. The needles are 7" long and made of carbon steel. The chisels included are one each of the following 1/2" square, 7" long chisels: a 3/4" flat, a 1-3/8" offset (weld flux), and a 2" flat chisel.

Recommended hose size is 5/16".
Performance figures are at 90 psi air pressure.

Needle Scalers

Features

- Adjustable bayonet-type needle housing lock allows adjustment without special tools.
- Choice of three needle materials permits custom selection for various surfaces.
- Rubber-faced throttle valve means positive sealing.
- Tested and approved in accordance with MIL-S-23492A (ships).
- Precision heat-treated needles for maximum performance.

Standard Equipment

- Lever throttle.
- 19 1/8" (3 mm) diameter steel needles, 5" (127 mm) long, NS11-22-19.



Series	Configuration	Retainer Type	Nozzle Type
172	L Lever	N Needle attachment	A1 Round needle housing
182	G Grip		

Model	Shape	lb (kg)	in (mm)	in (mm)	in (mm)	bpm	in	cfm
172LNA1	Round	5.3 (2.4)	13.8" (351)	0.6" (14)	0.9" (23)	5,500	1/4"	12
182LNA1	Round	5.8 (2.6)	15.0" (381)	1.1" (28)	0.9" (23)	4,000	1/4"	13

Recommended hose size is 5/16".
Performance figures are at 90 psi air pressure.

Chisel and Needle Scalers

Features

- Long nozzle section extends retainer life and permits the use of a variety of accessories.
- Positive chisel retainer is simple to operate.
- Strengthened head block holds up under the most extreme conditions.

Standard Equipment

- Positive lock chisel retainer.

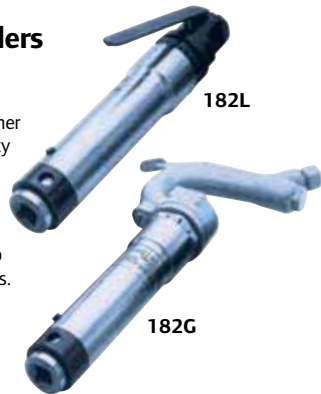

Needle Scaler Kit

182K1 Scaler Kit

- Model 182L scaler.
- Complete NS11A needle attachment with 5" long needles.
- One extra set of NS11-22-19 needles 5" long.
- One set of NS11-122-19 needles 7" long.
- One WF-14A - 6 - 1/8" angle chisel.
- One WF-14B - 6 - 1/8" straight chisel.
- One WF-14F - 7" flat chisel.
- PKB-1 or vinyl carrying case.



Model	Throttle	lb (kg)	in (mm)	in (mm)	in (mm)	bpm	in	cfm
172L	Lever	3.7 (1.7)	7.6" (193)	0.5" (13)	0.9" (23)	5,500	1/4"	12
182G	Grip	5.3 (2.4)	12.8" (325)	1.1" (28)	0.9" (23)	4,000	1/4"	13
182L	Lever	4.1 (1.9)	9.0" (229)	1.1" (28)	0.9" (23)	4,000	1/4"	13

Recommended hose size is 5/16".

Performance figures are at 90 psi air pressure.

Scaler and Needle Scaler Accessories

Needle Scaler Attachments

Needle scaler attachments are available for use on Series 172 or Series 182 scalers already in service. Order by one of the symbols shown.

Attachment Symbol	Description
NS11A	5" (127 mm) standard steel needles Round
NS11AS	5" (127 mm) stainless steel needles Needle
NS11A7	7" (178 mm) extended steel needles Housing
NS11BB	5" (127 mm) beryllium copper needles Rectangular
NS11BS	5" (127 mm) stainless steel needles Needle
NS11B7	7" (178 mm) extended steel needles Housing

Replacement Needles

Set of 19 needles.

Part Number	Description
NS11-22-19	5" (127 mm) standard steel needles
NS11-B22-19	5" (127 mm) beryllium copper needles
NS11-S22-19	5" (127 mm) stainless steel needles
NS11-122-19	7" (178 mm) extended steel needles

Chisels and Star Drills for Series 172 and Series 182 Scalers

WF-14-7-1/8" Chisel Blank

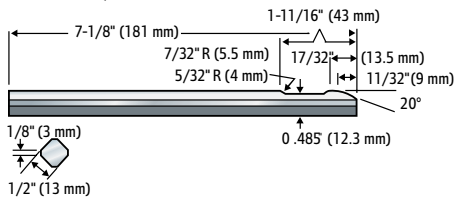

WF-14F-7" Flat Scaling Chisel

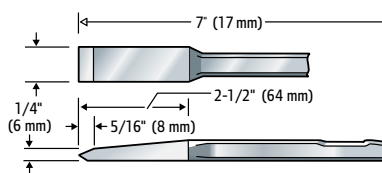

WF-14G-6" Gouge Chisel

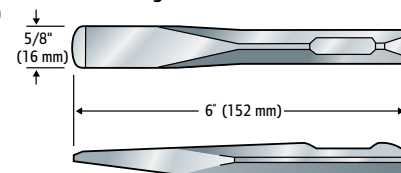

WF-14B-6-1/8" or WF-14B-11-1/2" Straight Scaling Chisel

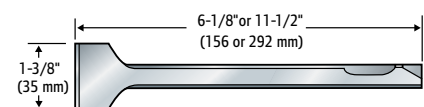

WF-14A-6-1/8" Angle Scaling Chisel

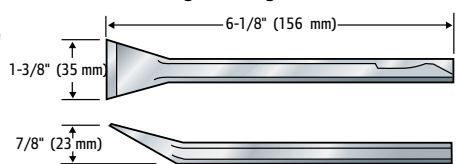

Finishing Tools

Classic Line Die Grinders

Rated Power: 20,000 – 85,000 rpm/0.1 hp (0.08 kW)

Standard Equipment

- Collet with insert.
- Collet wrenches.
- 6' x 7/32" ID (1.8 m x 6 mm) air hose and 18" exhaust overhose on models GH011A-600.
- 7' x 3/16" ID (2.1 m x 4.8 mm) air hose on models 7978, 7980, and 7114-E.
- 39830 cartridge air filter on models 7980 and 7114-E.

Turbine Grinders

Rated Power: 85,000 rpm/0.1 hp (0.08 kW)

Capacity: 1/8" carbide burr 3/8" mounted stone

- Ideal high-speed tools for final cleaning and polishing of dies.

Pencil Grinders

Rated Power: 60,000 rpm/0.1 hp (0.08 kW)

Capacity: 1/4" carbide burr 1/4" mounted stone

- Excellent for intricate grinding applications, including mold finishing.
- Trim, comfortable design enables precise control.
- Choice of rear exhaust or front exhaust.

Die Grinders

Rated Power: 20,000 rpm/0.1 hp (0.08 kW)

Capacity: 1/4" carbide burr 1/2" mounted stone

- Ideal for mold finishing, light deburring, and flash removal.



Model	rpm	Throttle Style	Output	Exhaust	Spindle Offset	in (mm)	in (mm)	oz (kg)	@ Free Speed	@ Free Speed	Standard Collet
7980-2	85,000	Lever	1/8" Collet	Front	0.6" (14)	5.6" (143)	14.0 (0.4)	9	84	31812-4	
7980-A	85,000	Twist	1/8" Collet	Front	0.6" (14)	5.6" (143)	14.0 (0.4)	9	84	31812-4	
7978	60,000	Slide	1/8" Collet	Front	0.4" (9)	5.6" (143)	5.5 (0.16)	6	80	46119-2	
GH011A-600-1	60,000	Twist	1/8" Collet	Rear	0.3" (8)	5.3" (136)	2.6 (0.07)	7	77	47568-1	
7114-E	20,000	Lever	1/8" Collet	Front	0.5" (12)	6.0" (152)	13.0 (0.37)	6	79	31812-4	

Optional Collet Inserts

For Models	Part Number	Description
7980 and 7114-E	31812 - ()	Collet insert
7978	46119 - ()	Collet insert
GH011A	47568 - ()	Collet insert

Grinders have 1/8" NPT inlet; 7/32" hose is recommended. Performance figures are at 90 psi air pressure.

Pencil Grinders

Carbide Burr and Mounted Stone



DG600G2

Standard Equipment

- Collet with 1/8" insert.
- Collet wrenches 47579, 47580.
- 6' x 7/32" ID (1.8 m x 6 mm) air hose and 18" exhaust overhose.

Accessories

- 3 mm collet 47568-2.
- 3/32" collet 47568-3.
- DG600G2K grinder kit contains model DG600G2 die grinder plus a molded carrying case, collet wrenches, exhaust hose assembly, inlet hose assembly and six 1/8" shank carbide burrs, including ball, tapered, tree, and assorted cylindrical burrs.

Model	rpm	Throttle Style	Output	Exhaust	Spindle Offset	in (mm)	@ Free Speed cfm	@ Free Speed dBA	Standard Collet Insert
DG600G2	60,000	Twist	1/8" Collet	Rear	0.3" (8)	5.3" (136)	7	77	47568-1
DG600G2K	60,000	Twist	1/8" Collet	Rear	0.3" (8)	5.3" (136)	7	77	47568-1

Grinders have 1/8" NPT inlet; 7/32" hose is recommended. Performance figures are at 90 psi air pressure.

Air Engraving Pen Kit

Features

- Knurled zoom throttle provides positive control.
- Steel housing dampens vibration, improves operator control.
- Variable speed permits tool to be used on a wide selection of materials.
- Carbide-tipped stylus holds percussive point.
- Easy to repair, reducing downtime.
- Three sets of tool flats eliminate need for special repair tools.

EP50K Engraving Pen Kit

- Model EP50 engraving pen, medium stylus standard.
- Flexible hose (DG100-130: 6' x 3/16").
- Three assorted styluses (fine, medium, coarse).
- Molded plastic carrying case DG10-RF.



EP50K

Optional Equipment

- Fine-point stylus EP50-515 (black).
- Medium-point stylus EP50-516 (steel color).
- Coarse-point stylus EP50-517 (green).
- Hose assembly (includes 1/8" NPT fittings) DG100-130.
- Stylus grinding collet EP50-514.

The Ingersoll Rand EP50 engraving pen is designed to meet your industrial engraving needs. Variable zoom throttle permits a wide range of engraving possibilities from hard alloys to brittle ceramics. The engraving pen can be easily disassembled with standard mechanic's tools. Comfort, quietness, and power have been ergonomically designed into this versatile tool. The engraving pen, including a standard stylus, can be purchased separately as model EP50.

Model	oz (kg)	in (mm)	in (mm)	bpm	dBA	Hose Pipe Tap in (mm)	Size Hose Recomm. in (mm)
EP50	5 (0.14)	5.6" (137)	0.3" (8)	18,750	75.5	1/8" (3)	7/32" (5.6)
EP50K (kit)	5 (0.14)	5.6" (137)	0.3" (8)	18,750	75.5	1/8" (3)	7/32" (5.6)

Medium-point stylus included.

Part Number	For Use With
ENGRAVING PEN TUNE-UP KIT	
EP50-TK1	EP50 engraving pen

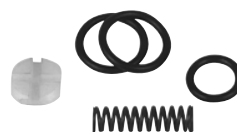

Random Orbital Sanders



Cyclone random orbital sanders deliver unsurpassed reliability, with moisture-resistant composite rotors, fully machined counterweights, and large counterweight bearings. They are lube-free when used with conventional air systems. Their high-performance air motors ensure high speed under load, and the finest in swirl-free finishes.

Cyclone Select Series

They are the ultimate in lightweight, efficient design, with comfort and performance to match. The Select Series' composite housing keeps overall weight at a mere 1.8 lb, with reduced vibration and quiet operation at just 78 dBA. High-efficiency air motors deliver 12,000 rpm performance.

Vacuum-ready models extract dust and particulates through and around the pad, then out a dedicated port, keeping foreign matter away from the motor. Special shroud material prevents surface-marring, and lightweight, flexible hoses provide excellent

maneuverability. Non-vacuum models can easily be converted to vacuum-ready with the simple addition of a vacuum adaptor, petal pad, and different shroud.

CycloVac System

This version of the Select Series features a unique self-generated vacuum system, with twice the power of the closest competitor. An eductor assembly produces a high-velocity vacuum of tool exhaust air that draws air and dust from the sanding area. A diffuser then channels both streams of air through the hose and into a double-bagged collection system. The result is a truly effective, self-contained, self-generating vacuum system in one compact, convenient package.

Cyclone Standard Series

These models incorporate traditional aluminum housings with textured comfort grips, and are available in non-vacuum, vacuum-ready, and venturi-vacuum models.

Cyclone Select Series

The Cyclone Select Series composite housing keeps overall weight at just 1.83 lb, with reduced vibration and quiet operation at just 78 dBA.

- High-efficiency air motors deliver true 12,000 rpm.
- One sander fits all hand sizes, with interchangeable soft rubber grip rings that fit securely around the top of the housing.



CycloVac System

- Unique double-bagging integral vacuum system provides a cleaner work environment.
- Delivers twice the vacuum power of the nearest competitor, and uses a disposable dust bag enclosed in a protective cover.

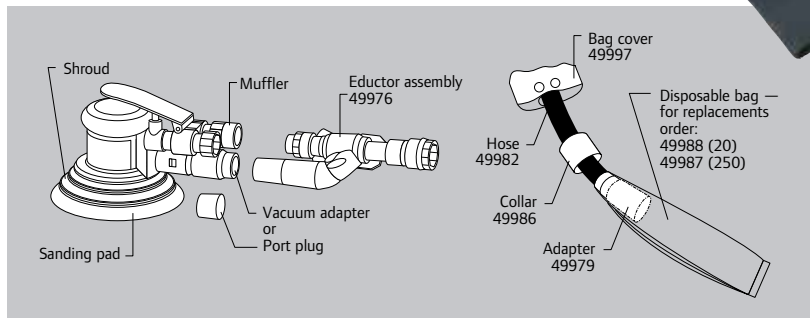

Cyclone Standard Series

- Select from non-vacuum models, vacuum-ready models for use with central or portable vacuum systems, or venturi-vac models with a self-contained hose and dust collection bag.
- Non-vacuum models can be converted to vacuum-ready status with an available conversion kit.
- Comfortable cushion grip provides excellent feel and control.



Cyclone Select Series and CycloVac System (composite housing)

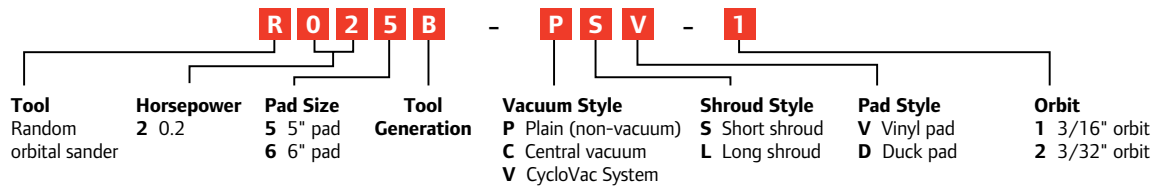

Model	Shroud Style	Pad Face in (mm)	1 min. rpm	hp	@ Free Speed scfm	Female	lb (kg)
NON-VACUUM							
R025B-PSV-1*	Short	5" (127)	Vinyl	12,000	0.2	15.8	5/16"-24 1.8 (0.8)
R026B-PSV-1	Short	6" (152)	Vinyl	12,000	0.2	15.8	5/16"-24 1.9 (0.9)
R025B-PSV-2	Short	5" (127)	Vinyl	12,000	0.2	15.8	5/16"-24 1.8 (0.8)
R026B-PSV-2	Short	6" (152)	Vinyl	12,000	0.2	15.8	5/16"-24 1.9 (0.9)
VACUUM-READY**							
R025B-CSV-1*	Short	5" (127)	Vinyl	12,000	0.2	15.8	5/16"-24 1.9 (0.9)
R026B-CSV-1	Short	6" (152)	Vinyl	12,000	0.2	15.8	5/16"-24 1.9 (0.9)
R026B-CSV-2	Short	6" (152)	Vinyl	12,000	0.2	15.8	5/16"-24 1.9 (0.9)
R025B-CLV-1	Long	5" (127)	Vinyl	12,000	0.2	15.8	5/16"-24 1.9 (0.9)
R026B-CLV-1	Long	6" (152)	Vinyl	12,000	0.2	15.8	5/16"-24 1.9 (0.9)
CYCLOVAC***							
R025B-VLV-1**	Long	5"(127)	Vinyl	12,000	0.2	15.8	5/16"-24 1.9 (0.9)
R026B-VLV-1**	Long	6" (152)	Vinyl	12,000	0.2	15.8	5/16"-24 1.9 (0.9)

Cyclone Standard Series (aluminum housing)

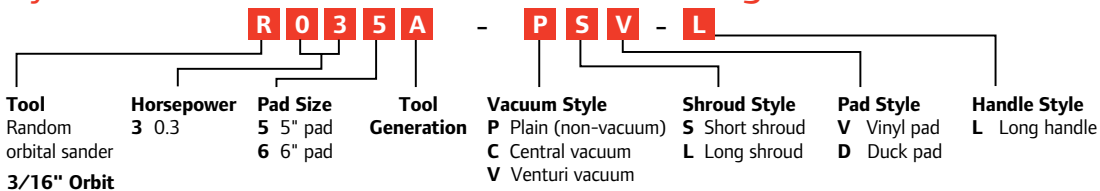

Model	Long Handle	Pad Face in (mm)	1 min. rpm	hp	@ Free Speed scfm	Female	Palm style lb (kg)	Long handle lb (kg)
NON-VACUUM								
R035A-PSV*	R035A-PSV-L	5" (127)	Vinyl	10,000	0.3	18.5	5/16"-24 2.3 (1.0)	2.6 (1.2)
R036A-PSV*	R036A-PSV-L	6" (152)	Vinyl	10,000	0.3	18.5	5/16"-24 2.3 (1.0)	2.6 (1.2)
VACUUM-READY**								
R035A-CSV*		5" (127)	Vinyl	10,000	0.3	18.5	5/16"-24 2.4 (1.1)	N/A
R036A-CSV		6" (152)	Vinyl	10,000	0.3	18.5	5/16"-24 2.4 (1.1)	N/A
VENTURI-VAC***								
R035A-VLV**		5" (127)	Vinyl	10,000	0.3	18.5	5/16"-24 2.4 (1.1)	N/A
R036A-VLV**		6" (152)	Vinyl	10,000	0.3	18.5	5/16"-24 2.4 (1.1)	N/A

*Most popular models.

**Sanding pads have industry-standard hole pattern for "thru-the-pad" vacuum pickup.

For use with coated sanding discs with pre-punched holes.

Air inlet is 1/4" NPT female; recommended air pressure is 90 psi.

Recommended hose size is 5/16" (8 mm) I.D.

***Standard Equipment: (3) 49973 Bag
(1) 49997 Bag cover
1 49979 Adapter
1 49982 Hose
1 49986 Collar

ARO Sanders — Elite Sanders (composite housing)

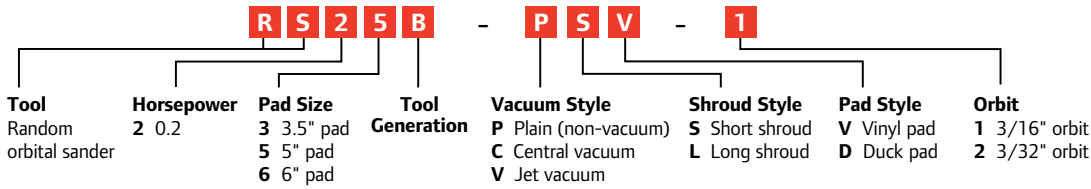

Model	Shroud Style	Pad Face	rpm	hp	@ Free Speed	Female	lb (kg)
NON-VACUUM							
RS23B-PLV-1	Long	Vinyl	12,000	0.2	15.8	5/16"-24	1.8 (0.8)
RS23B-PLV-2	Long	Vinyl	12,000	0.2	15.8	5/16"-24	1.8 (0.8)
RS25B-PSV-1*	Short	Vinyl	12,000	0.2	15.8	5/16"-24	1.8 (0.8)
RS26B-PSV-1	Short	Vinyl	12,000	0.2	15.8	5/16"-24	1.9 (0.9)
VACUUM-READY**							
RS26B-CSV-1	Short	Vinyl	12,000	0.2	15.8	5/16"-24	1.9 (0.9)
RS25B-CLV-1	Long	Vinyl	12,000	0.2	15.8	5/16"-24	1.9 (0.9)
RS26B-CLV-1	Long	Vinyl	12,000	0.2	15.8	5/16"-24	1.9 (0.9)
CYCLOVAC***							
RS25B-VLV-1**	Long	Vinyl	12,000	0.2	15.8	5/16"-24	1.9 (0.9)
RS26B-VLV-1**	Long	Vinyl	12,000	0.2	15.8	5/16"-24	1.9 (0.9)

ARO Sanders — Classic Sanders (aluminum housing)

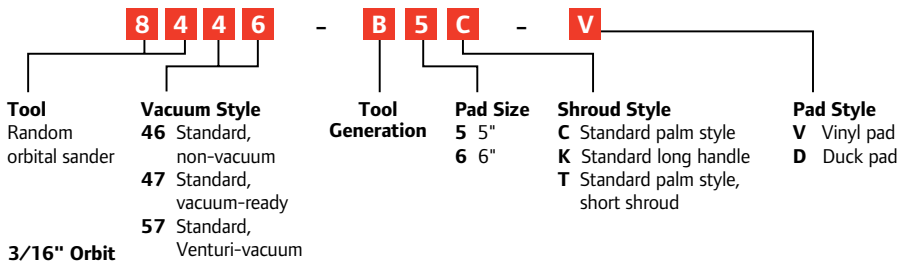

Model	Pad Face	rpm	hp	@ Free Speed	Female	lb (kg)
CLASSIC LINE						
8446-B5C-V	Vinyl	10,000	0.3	18.5	5/16"-24	2.3 (1)
8446-B6C-V	Vinyl	10,000	0.3	18.5	5/16"-24	2.3 (1)
8447-E5T-V	Vinyl	10,000	0.3	18.5	5/16"-24	2.4 (1)
8447-E6T-V	Vinyl	10,000	0.3	18.5	5/16"-24	2.4 (1)
8457-B5T-V	Vinyl	10,000	0.3	18.5	5/16"-24	2.4 (1)
8457-B6T-V	Vinyl	10,000	0.3	18.5	5/16"-24	2.4 (1)

*Most popular models.

**Sanding pads have industry-standard hole pattern for "thru-the-pad" vacuum pickup.

For use with coated sanding discs with pre-punched holes.

Air inlet is 1/4" NPT female; recommended air pressure is 90 psi.

Recommended hose size is 5/16" (8 mm) I.D.

***Standard Equipment: (3) 49973 Bag
(1) 49997 Bag cover
1 49979 Adapter
1 49982 Hose
1 49986 Collar

Random Orbital Sander Accessories

Vacuum Kits and Accessories

Part Number	Description
JET-VAC / CYCLOVAC CONVERSION KITS*	
RSVK-5	5" vacuum conversion kit
49978	6" vacuum conversion kit
JET-VAC / CYCLOVAC ACCESSORIES	
49600	6' (1.8 m) hose equipped with molded 1" ID cuffs at each end
49973	Disposable vacuum bag (single)
49997	Bag cover
49979	Vacuum adapter
49982	Vacuum hose
49986	Vacuum hose collar
49976	Eductor assembly

* To convert nonvac tools to vacuum

Part Number	Description
SWIVEL VACUUM ADAPTERS	
4151-A809A-25	1" (25 mm) adapter
4151-A809A-28	1-1/8" (28 mm) adapter
4151-A809A-32	1-1/4" (32 mm) adapter
VACUUM HOSES*	
49600	6' (1.8 m) hose
*Equipped with molded 1" I.D. cuffs at each end.	
DUST COLLECTION BAG	
355-402	Dust collection bag
JET-VAC / CYCLOVAC SERIES DISPOSABLE VACUUM BAGS	
49988	Vacuum bag (20 pack)
49987	Vacuum bag (250 pack)
49973	Vacuum bag (single)

Misc. Accessories

Part Number	Description
PAD WRENCHES*	
351-69	For all aluminum housing non-vacuum models
354-69	For all aluminum housing vacuum models
*Use to remove sanding pad. Included with every tool.	
SPANNER WRENCHES*	
48869	For all composite housing models
44548	For all aluminum housing models
*Use to remove the lock ring securing the motor assembly.	
GRIP RINGS*	
49801	Small, grey (optional)
49798	Medium, black (standard)
49799	Large, blue (optional)
*Alternate grip rings for Select Series models.	
SERVICE KITS	
49837	Composite housing models
49846	Aluminum housing models



Sanding Backer Pads

Part Number	Description
Non-vacuum — 3/8" (composite housing models)	
49878-1	5" vinyl face
49879-1	6" vinyl face
Non-vacuum — 3/8" (aluminum housing models)	
49094-1	5" (127 mm) diameter, vinyl face diamond pattern
49095-1	5" (127 mm) diameter, duck face
351-825-6A	6" (152 mm) diameter, vinyl face diamond pattern
Vacuum* — 3/8"	
49096-1	5" (127 mm) diameter, vinyl face petal pattern
49099-1	6" (152 mm) diameter, vinyl face petal pattern
*For use with PSA coated sanding discs with industry-standard pre-punched holes.	

VACUUM PADS	
49694	6" (152 mm) diameter hook and loop pattern
SANDING PADS	
49095	5" sanding pad Random Orbital Sanders: Cyclone Standard, Cyclone Select, Jet-VAC / CycloVAC
49097-1	6" sanding pad Random Orbital Sanders: Cyclone Standard, Cyclone Select, Jet-VAC / CycloVAC

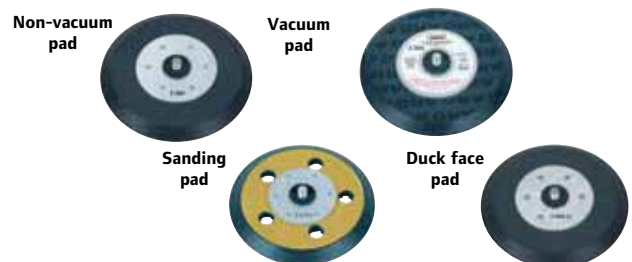



Accessories

Proper conditioning of compressed air is essential to ensure maximum performance and service life from pneumatic power tools and equipment. The small initial investment for installation of air preparation units in an air line system will pay long-term dividends in increased productivity, consistent quality, and decreased maintenance costs.

ARO offers an extensive line of air line filters, regulators, and lubricators, including individual units, piggybacks, and combos, to meet your exact air preparation requirements.

Filters, Regulators, and Lubricators (FRLs)

ARO Mini Series Combination Units

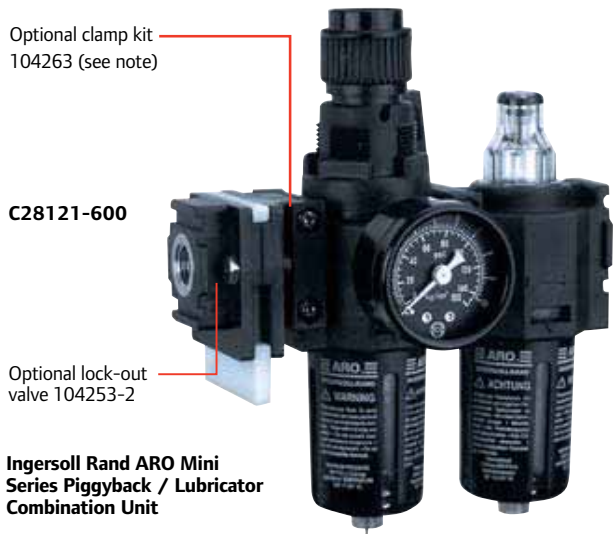

Dimensional Data
Dimensions – in (mm)

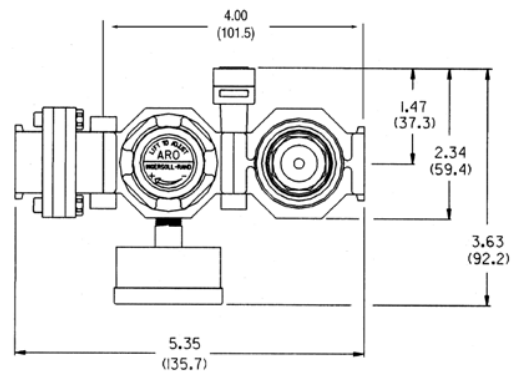
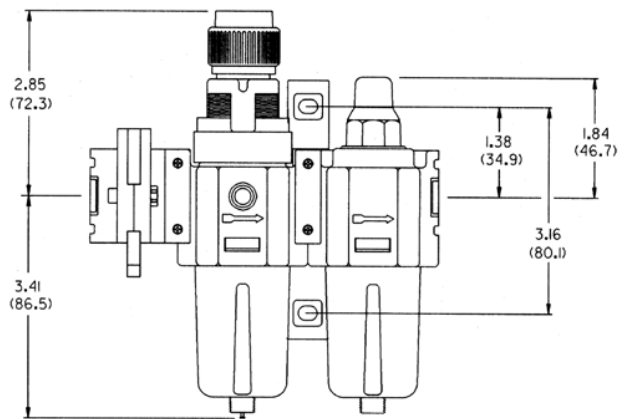

PiggyBack Lubricator

Performance	Specifications
Max Inlet Pressure	150 psig (10.4 bar)
Temp Range	0° – 125° F (-18° – 52° C)
Filter Element	20 micron
Pressure Range in Regulator	5 – 125 psig (0.4 – 8.6 bar)
Gauge	0 – 150 psi
Gauge Port	1/8" NPT

Port Size NPT	Models		Weight lb (kg)	Components	
	with T-Mounts	without T-Mounts		Filter/Regulator	Lubricator
PUSH DRAIN — POLYCARBONATE BOWL WITH BOWL GUARD					
1/8"	C28111-600	C28112-600	4.14 (1.88)	P29112-600	L26111-100

Note: Order lock-out valve separately and attach to filter inlet with clamp kit (104263). To order modular model with pipe nipples, place a "3" in the sixth position of the model number. Example: C28XX3-XXX.

FRLS (cont'd)

ARO Compact Series Piggyback Lubricators

Port Size NPT	Models		Weight lb (kg)	Components	
	Modular	Nippled		Piggyback	Lubricator
PUSH DRAIN — METAL BOWL WITH SIGHT GLASS					
1/4"	C28221-610	C28223-610	4.1 (1.9)	P29221-610	L26221-110
3/8"	C28231-610	C28233-610	4 (1.8)	P29231-610	L26231-110
1/2"	C28241-610	C28243-610	3.9 (1.8)	P29241-610	L26241-110
PUSH DRAIN — POLYCARBONATE BOWL WITH BOWL GUARD					
1/4"	C28221-600	C28223-600	4.1 (1.9)	P29221-600	L26221-100
3/8"	C28231-600	C28233-600	4 (1.8)	P29231-600	L26231-100
1/2"	C28241-600	C28243-600	3.9 (1.8)	P29241-600	L26241-100

Note: Two-piece modular models include one 104171 "T" bracket and one 100067 gauge. Pipe-nippled models include one 100067 gauge and one appropriate-sized pipe nipple. For pipe-nippled FRL combo units with automatic drain, order individual filter, regulator, lubricator components, and pipe nipples. To order modular models without "T" brackets, place a "2" in the sixth position of the model number. Example: CXXXX2-XXX. Not all menu combinations are valid. See price book to verify.



**C28241-610
Piggyback/Lubricator**

1/4", 3/8", and 1/2" Ports

Ordering

Select the basic model number that represents the port size and bowl option required. Modular models listed include gauges and "T" brackets, and are shipped assembled. Pipe-nippled models include gauge and nipple, and are shipped unassembled. If other options are required, order each unit separately. For BSP threads, add -B to the end of the model number.

Performance	Specifications
Max Inlet Pressure	Polycarbonate bowl — 150 psig (10.4 bar) Metal bowl — 175 psig (12 bar)
Operating Temp Range	Polycarbonate bowl — 0° – 125° F (-18° – 52° C) Metal bowl — 0° – 175° F (-18° – 79° C)
Filter Element	40 micron
Pressure Range In Regulator	5 – 125 psig (0.3 – 8.6 bar)
Gauge	0 – 160 psi
Gauge Port	1/4" NPT
Filter Drain	Manual (standard); automatic (optional)

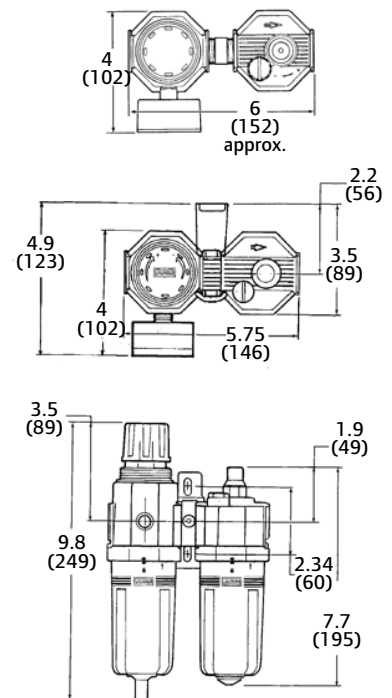

Dimensional Data
Dimensions – in (mm)

MS Series Industrial Interchange

- Economical automatic-type, one-way shutoff coupler
- Easy, push-to-connect use

Body Size	NPT Or Hose Stem ID	Average Airflow cfm*	Automatic NPT Part Number	Hose Stem ID Part Number
FEMALE COUPLERS				
1/4"	1/4"	36	N/A	MSCF22
1/4"	3/8"	36	N/A	MSCF23
3/8"	3/8"	67	420ATH	MSCF33
3/8"	1/2"	67	440ATH	N/A
1/2"	1/2"	126	N/A	MSCF44

Body Size	NPT Or Hose Stem ID	Average Airflow cfm*	Female NPT Part Number	Hose Stem ID Part Number
FEMALE PLUGS				
1/4"	1/8"	36	MSPF21	N/A
1/4"	1/4"	36	MSPF22	MSPH22
1/4"	3/8"	36	MSPF23	MSPH23
3/8"	1/4"	67	MSPF32	N/A
3/8"	3/8"	67	MSPF33	MSPH33
3/8"	1/2"	67	45ATH	MSPH34
1/2"	3/8"	126	MSPF43	N/A
1/2"	1/2"	126	MSPF44	MSPH44
1/2"	3/4"	126	MSPF46	N/A

Body Size	NPT Or Hose Stem ID	Average Airflow cfm*	Automatic NPT Part Number	Hose Stem ID Part Number
MALE COUPLERS				
1/4"	1/4"	36	N/A	MSCM22
1/4"	3/8"	36	N/A	MSCM23
3/8"	1/4"	67	N/A	4100ATH
3/8"	3/8"	67	430ATH	MSCM33
1/2"	1/2"	126	N/A	MSCM44

Body Size	NPT Or Hose Stem ID	Average Airflow cfm*	Male NPT Part Number	Hose Stem ID Part Number
MALE PLUGS				
1/4"	1/8"	36	MSPM21	N/A
1/4"	1/4"	36	MSPM22	MSPH22
1/4"	3/8"	36	MSPM23	MSPH23
3/8"	1/4"	67	MSPM32	N/A
3/8"	3/8"	67	PRPM33	MSPH33
3/8"	1/2"	67	MSPM34	MSPH34
1/2"	3/8"	126	MSPM43	N/A
1/2"	1/2"	126	MSPM44	MSPH44

*At 90 psig inlet and 10 psig pressure drop.



Automatic NPT



Hose Stem ID



Manual NPT



Female NPT



Hose Stem ID



45ATH



Automatic NPT



Hose Stem ID



4100ATH



430ATH



Male NPT



Hose Stem ID



8440



8451-1

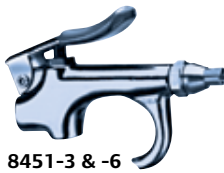

8451-3 & -6



7444-K



- Permanently coiled hoses automatically return to their original position, keeping them off the floor and out of your way as you work.
- Made from abrasive-resistant and memory-resilient Nylon II.
- For use with air, gases, water, and liquids compatible with Nylon II.
- Certified to a maximum pressure of 200 psi.
- Fittings and hose ends are protected by spring guards.
- Available with diameters of 1/4", 3/8", 1/2", and 1-1/2".
- Available in bulk lengths of 12', 25', 50', and 100'.

Blow Guns

Part Number	Description
8440 SERIES	
8440	Safety yellow, lightweight, polyester blow gun

8451 SERIES	
8451-1	Standard tip gun; generates concentrated stream of air
8451-2	Shield tip gun; generates cone of air for chip deflection

8451 ACCESSORIES	
8451-3	3" (76 mm) extension tip
8451-6	6" (152 mm) extension tip

Part Number	Description	Max Inlet Pressure
7444 SERIES		
7444-J	Safety blow gun	100 psi
7444-K	Safety blow gun	180 psi

Nylon Recoil Hoses

Part Number	Hose Length		Working Length	Compact Size	Outside Coil Diameter	Male NPT Fitting
	Hose Inside Diameter	Max				
SWIVEL BOTH ENDS						
N14-12B	1/4"	12'	10'	6"	3-1/2"	1/4"
N14-25B	1/4"	25'	22'	10-1/2"	3-1/2"	1/4"
N14-50B	1/4"	50'	45'	21"	3-1/2"	1/4"
N38-124B	3/8"	12'	10'	5"	5-5/8"	1/4"
N38-254B	3/8"	25'	21'	10-1/4"	5-5/8"	1/4"
N38-504B	3/8"	50'	44'	21"	5-5/8"	1/4"
N38-12B	3/8"	12'	10'	5"	5-5/8"	3/8"
N38-25B	3/8"	25'	21'	10-1/4"	5-5/8"	3/8"
N38-50B	3/8"	50'	44'	21"	5-5/8"	3/8"
N12-12B	1/2"	12'	9'	5"	9"	1/2"
N12-25B	1/2"	25'	18'	9"	9"	1/2"
N12-50B	1/2"	50'	41'	18"	9"	1/2"
N34-12B	3/4"	12'	10'	4-1/2"	12-1/2"	3/4"
N34-25B	3/4"	25'	17'	9"	12-1/2"	3/4"
N34-50B	3/4"	50'	35'	16"	12-1/2"	3/4"

Gloves

With this line of industry-leading work gloves from Ingersoll Rand, you can pair up the industry's toughest tools — ours — with gloves that offer the utmost in protection, comfort, and performance.

Part Number	Description	Quantity	Size
IR-G SERIES			
IR-GL-1	Ingersoll Rand mechanic gloves	1 pair	Large
IR-CXL-1	Ingersoll Rand mechanic gloves	1 pair	Extra-large
TNT-G SERIES			
TNT-GL-1	Titanium impact gloves	1 pair	Large
TNT-GXL-1	Titanium impact gloves	1 pair	Extra-large

IR-G Series

- Provide protection during day-to-day jobs
- Machine washable Clarino® synthetic palm construction allows full finger dexterity and enhanced tool handling
- Spandex top ensures comfortable fit



Protection

TNT-G Series

- Silicon finger and thumb grippers enhance tool control
- Neoprene top offers impact protection while allowing increased comfort and dexterity
- 3 mm gel palm pads reduce hand fatigue
- Ideal for Ingersoll Rand titanium tools



Protection, comfort, and performance

Safety Information for Finishing Tools

General Safety Tips

Ingersoll Rand grinders are built to reflect a host of governmental and industry safety codes, regulations, and standards. Others may apply as well, depending upon your specific location. Familiarize yourself with all of them before using any finishing tool.

Keep hands, loose clothing, and long hair away from the rotating ends of tools.

Personal Protective Equipment (PPE)

PPE is not intended as a substitute for safe workplace practices or well-engineered tools.

In general, PPE should be appropriate to the tool used and the type of work performed. Be sure to inspect, clean, repair, and properly store PPE.

Eye and Face Protection

Protective eyewear must be worn by everyone in or around the area where the tool is being operated. Types of protection include approved safety glasses with side protection, goggles, and face shields. The best protection is provided when safety glasses or goggles are worn with face shields. Eye protective devices should allow for air to circulate between the eye and the lens.

Head Protection

There are a variety of situations in which hard hats must be worn, such as wherever there is danger of falling or flying objects, or electrical hazards.

Hearing Protection

Grinders generate considerable noise when operated. Appropriate ear muffs or ear plugs should be worn.

Safety Shoes/Boots

Safety shoes with impact, compression, and/or puncture protection must be worn in work areas where those types of hazards exist.

Gloves

Make sure the gloves being used are the right type for the job, since insufficient gloves may provide no protection. Gloves should fit properly and shouldn't increase the grip force required to control the tool. When wearing gloves, always be sure that they won't prevent the throttle mechanism from being released.

Breathing Apparatus

Respiratory protection suited to particular dust or particle hazards may be required. Appropriate respirators must be worn if it is not possible to ventilate the work area properly.

Body Protection

Under certain circumstances, body protection may also be needed. This could include coveralls, aprons, arm guards, etc.

Air Delivery System

There are a number of precautions you should take to ensure that your air delivery system is operating safely and efficiently.

Air Pressure

Use clean, dry air at 90 psi (6.2 bar/620 kPa) maximum air pressure at the inlet. Higher pressure can cause hazardous situations such as excessive grinder speed, line rupture, and incorrect torque output. Pressure below 90 psi isn't unsafe, but will limit the tool's power.



Air Hose

Periodically check air hoses for any defects, such as kinks, leaks, fraying, etc., which can cause line ruptures and injuries. Correct any defects before connecting hoses to any tools.

Protect air supply lines and hoses from traffic damage or other equipment — preferably by suspending them overhead.

Air Breaker

Use properly sized air breakers (safety air fuses) at the source of the air supply or branch lines if working with hoses with inside diameters larger than one-half inch. If a hose fails, an air breaker limits hose whipping. Never approach a whipping hose since it can cause serious injury. Turn off the air supply before approaching the hose.

Couplings and Connections

Use correctly sized quick-disconnect couplings on grinders with abrasive wheels smaller than 4 inches in diameter. These help maintain maximum air pressure along the length of an air line.

Make sure all connections are secure, especially threaded tool connections, which can work loose if not properly tightened.

A safety cable should also be used when using hoses with inside diameters larger than one-half inch.

Connecting the Tool

Before connecting an air line to a tool, safely blow out the line to remove any moisture or dirt.

Always have the air supply turned off when attaching or detaching any air tool. If you're using a grinder with an abrasive wheel 4 or more inches in diameter, be sure to have a hose whip threaded into the air inlet. Before connecting the air line to the whip, be sure to clean off any dirt or grit that may have accumulated on the fittings.

Abrasive Wheel Handling and Mounting

If an abrasive wheel is carelessly handled, mounted, stored, or used, it can disintegrate and cause serious injury. It's vital that you follow important safety precautions.

Wheel Selection and Speed Ratings

Choose and mount abrasive wheels with a minimum amount of handling. Take extra care to avoid dropping a wheel.

Always select the right wheel for the job and the tool being used — make sure the wheel has a speed rating equal to or greater than the grinder itself. Refer to the manufacturer's plate on the grinder, which indicates the tool's rated speed and maximum wheel size. Check the wheel's label for the manufacturer's maximum rated safe operating speed. Never exceed this speed. Don't use a wheel if it doesn't show a rated speed.

Don't use a grinder without first checking its speed with a calibrated tachometer.

Wheel Inspection

Inspect all grinding wheels for chips or cracks prior to mounting. Do not use a wheel that is chipped, cracked, or otherwise damaged.

Abrasive Wheel Mounting (through-hole design)

When mounting these types of wheels, always use the flanges that were supplied with the grinder. Make sure they're the same diameter, aren't accidentally reversed, and have matched recesses. Mismatched or reversed flanges can stress the wheel and cause it to fail. Never use washers in place of flanges.

The wheel and the flanges must be wiped clean to ensure even contact, with no pressure points. Clamp the wheel flanges correctly against the blotter with adequate pressure against the wheel.

The grinder's arbor shank should extend through the wheel, with threads showing both in and through the outside flange. Wheels with through-hole designs should have about 0.007" (0.17 mm) maximum diametral clearance around the arbor shank. Do not use reducing bushings to adapt a wheel to any arbor shank unless such bushings are supplied, or recommended, by the wheel manufacturer.

Tighten the end nut carefully with a hand wrench — just tight enough to hold the wheel firmly in place. Over-tightening the end nut can stress the wheel and cause it to break.

Blotters

A blotter is a compressible washer that cushions the flanges, distributes their pressure evenly, and protects them from the abrasive surface of the wheel. Be sure to use a new blotter if mounting a wheel that requires one, but doesn't already have one affixed by the wheel manufacturer. Don't use loose, scuffed, or damaged blotters.

Abrasive Wheel Mounting (threaded wheel design)

Threaded abrasive wheels have threaded steel bushings molded into the wheel so they can be threaded onto the end of the grinder spindle. When mounting a threaded wheel, the back flange should be flat, without a recess. If a flange with recesses is used, the bushing can be pulled out of the wheel when it's tightened into place. Use a wheel retaining screw if one is provided with your grinder.

Speed Test

After an abrasive wheel is mounted, a full speed test should be run. Hold the grinder under a steel bench or inside a casting, making sure everyone is out of the way and that the open part of the guard is not facing anyone. Turn the tool on and hold it at full throttle for one minute. If the wheel is damaged or weakened, this is usually when it will fail. If the wheel does fail and you need to mount a replacement wheel, be sure to turn off the air, disconnect the hose, and follow the mounting steps closely.

If the grinder's guard was struck by a disintegrating wheel, install a new guard before replacing the wheel.

Protective Grinder Features

Ingersoll Rand puts considerable effort and resources into designing the safest, most ergonomic air grinders possible. Safety features built into our grinders should never be overridden or compromised.



Wheel Guards

The wheel guard is one of the most important safety features on a grinder. There are two types of guards — adjustable and integral (i.e., non-adjustable). All wheel guards should be mounted between the wheel and the operator, and be tightened securely.

Never use a grinder without the manufacturer's furnished wheel guard installed. Do not use an unguarded grinder except for internal work where the work provides protection. Always replace a damaged or severely worn wheel guard.

Automatic Shut-off Lever

Some grinder models feature an automatic throttle shut-off lever design.

Integral Spring-loaded Throttle Latch

Most pneumatic tools shut off when the trigger lever is released. Some grinder models feature an integral spring-loaded latch that also prevents the tool from running if it's accidentally dropped or laid on the lever.

Safe Grinding Techniques

Even properly handled, mounted, and guarded grinder wheels can fail and cause injury if they're used incorrectly or carelessly.

The work area must be uncluttered and ventilated. Make sure all co-workers are a safe distance away.

Never carry or drag a tool by the air hose. Avoid accidental starting by keeping your hand away from the trigger until you're ready to use the tool.

Be sure you have good footing and a balanced posture. Secure the work in place using clamps or a vice. Never clamp a hand-held grinder in place or grind above anyone else, or above your head. Avoid sending sparks upward.

Begin grinding by slowly applying pressure to the work surface until the grinder wheel gradually warms up. Make smooth contact with the surface and avoid excessive pressure, which can overload the wheel and cause catastrophic failure.

Never grind using the flat side of cut-off wheels. Use a wheel and/or grinder designed for that specific application.

Never put a running grinder down on your bench, work surface, or floor. When finished grinding, let the wheel come to a halt while it's still in contact with the work surface.

Keep the grinder wheel away from any contact with fluids, such as water or oil. A wheel can quickly absorb enough liquid to cause it to become dangerously imbalanced.

Other Resources

Every new Ingersoll Rand tool comes with an accompanying Product Safety Information manual. These manuals cover important safety topics, as well as other user information. You should take the time to review this information before using the tool. You can print copies of any Ingersoll Rand Product Safety Information manual, or other product information manuals from our website, ingersollrandproducts.com.

In General ...

- Always operate, inspect, and maintain tools in accordance with American National Standards Institute Safety Code for Portable Air Tools (ANSI B186.1).
- For safety, top performance, and maximum durability of parts, operate tools at 90 psi (6.2 bar/620 kPa) maximum air pressure at the inlet.



- Air-powered tools can vibrate in use. Vibration, repetitive motions, or uncomfortable positions may be harmful to your hands and arms. Stop using any tool if discomfort, tingling feeling, or pain occurs. Seek medical advice before resuming use.
- Always turn off the air supply and disconnect the air supply hose before installing, removing, or adjusting any accessory on a tool, or before performing any maintenance on a tool.
- Keep hands, loose clothing and long hair away from rotating end of tools.
- Anticipate and be alert for sudden changes in motion during start-up and operation of any power tool.
- Check for excessive speed and vibration before operating.
- Tool shafts may continue to rotate briefly after throttle is released.

- Do not lubricate tools with flammable or volatile liquids such as kerosene, diesel, or jet fuel.
 - Do not remove any labels. Replace any damaged label.
 - Use accessories recommended by Ingersoll Rand.
- Note: Always read the operators' manual before using any air tool.

When Using Grinders ...

- Do not use tools if actual free speed exceeds the nameplate rpm.
- Before mounting a wheel, after all tool repairs, and whenever a grinder is issued for use, check the free speed of the grinder with a tachometer to make certain its actual speed at 90 psig (6.2 bar/620 kPa) does not exceed the rpm stamped or printed on the nameplate. Grinders in use on the job must be similarly checked at least once each shift.

- Always use the Ingersoll Rand wheel guard furnished with the grinder. Failure to do so could result in injury.
- Do not use a grinder without the recommended wheel guard. Do not use any wheel for which the operating speed listed on the blotter is lower than the actual free speed of the grinder.
- Inspect all grinding wheels for chips or cracks prior to mounting. Do not use a wheel that is chipped or cracked or otherwise damaged. Do not use a wheel that has been soaked in water or any other liquid.
- Make certain the grinding wheel properly fits the arbor. The wheel should not fit too snugly or too loosely. Plain hole wheels should have about 0.007" (0.17 mm) maximum diametral clearance. Do not use reducing bushings to adapt a wheel to any arbor unless such bushings are supplied by or recommended by the wheel manufacturer.
- After mounting a new wheel, hold the grinder under a steel workbench or inside a casting and run it for at least 60 seconds. Make certain no one is within the operating plane of the grinding wheel. If the wheel is defective, improperly mounted or the wrong size and speed, this is the time it will usually fail.
- When starting a cold wheel, apply it to the work slowly until the wheel gradually warms up. Make smooth contact with the work, and avoid any bumping action or excessive pressure.
- Always replace a damaged, bent, or severely worn wheel guard. Do not use a wheel guard that has been subjected to a wheel failure.
- Make certain the wheel flanges are at least one-third the diameter of the grinding wheel, free of nicks, and burrs, and sharp edges. Always use the wheel flanges furnished by the manufacturer; never use a makeshift flange or a plain washer.
- Guard opening must face away from operator. Bottom of wheel must not project beyond guard.
- Always use a wheel blotter between each wheel flange and the wheel. The blotters must be at least as large in diameter as the wheel flanges.
- Do not attempt to disassemble the controller. The controller is available only as a unit and is guaranteed for the life of the tool if it is not abused.

Warning Label Identification

Failure to observe the following warnings could result in injury.

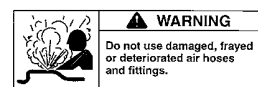
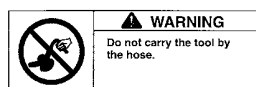
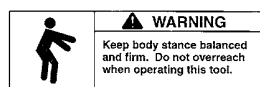
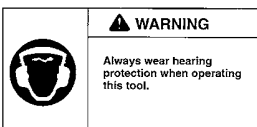
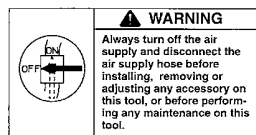
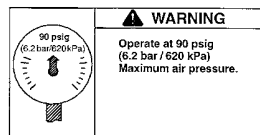
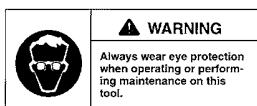



Ingersoll Rand (NYSE:IR) advances the quality of life by creating comfortable, sustainable and efficient environments. Our people and our family of brands—including Club Car®, Ingersoll Rand®, Thermo King® and Trane®—work together to enhance the quality and comfort of air in homes and buildings; transport and protect food and perishables; and increase industrial productivity and efficiency. We are a \$13 billion global business committed to a world of sustainable progress and enduring results.



www.ingersollrandproducts.com

Distributed by:

Ingersoll Rand, IR and the IR logo are trademarks of Ingersoll Rand, its subsidiaries and/or affiliates. All other trademarks are the property of their respective owners. Nothing contained on these pages is intended to extend any warranty or representation, expressed or implied, regarding the product described herein. Any such warranties or other terms and conditions of sale of products shall be in accordance with Ingersoll Rand's standard terms and conditions of sale for such products, which are available upon request. Product improvement is a continuing goal at Ingersoll Rand. Designs and specifications are subject to change without notice or obligation.